

*Fourth
Building
in the
Fourth*

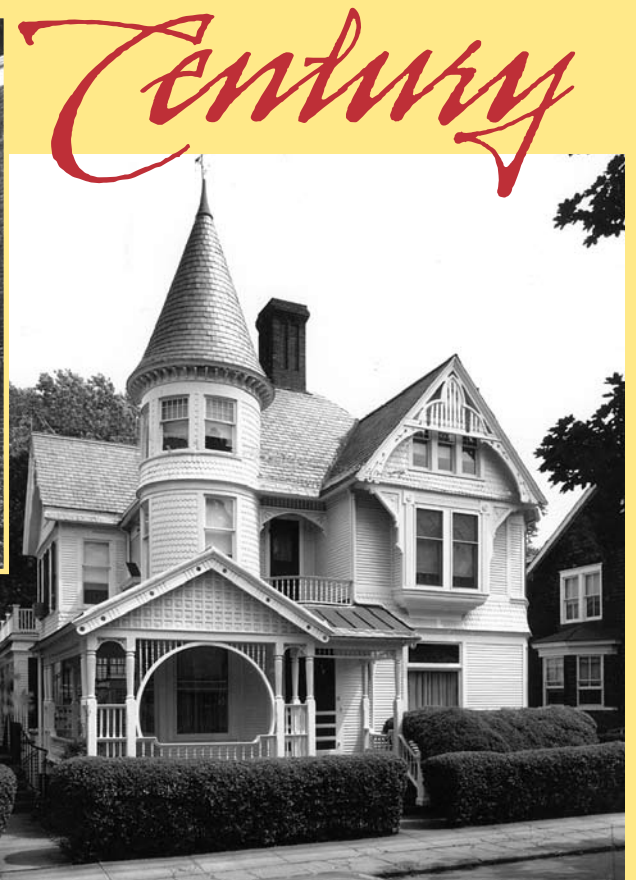
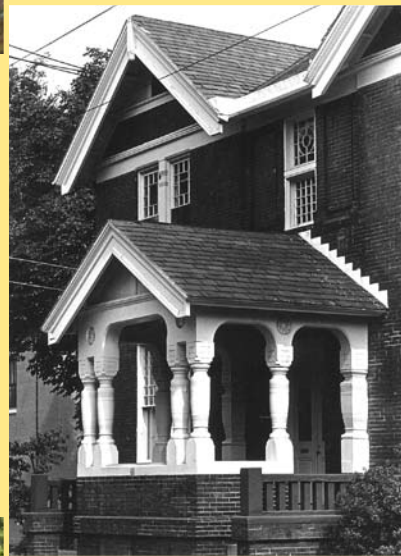

Building In The Fourth Century

Annapolis Historic District Design Manual

THE ANNAPOLIS HISTORIC PRESERVATION COMMISSION

Updated and Expanded 2011 by
Lisa M. Craig, Chief of Historic Preservation
Shari Phippen, Historic Preservation Assistant

Edited and Revised 2009 by Jon Arason, AICP, Director
Patricia M. Blick, Chief of Historic Preservation
Shari Phippen, Historic Preservation Assistant & Jean B. Russo, Ph.D.

Edited and Revised 2007 by Donna C. Hole, Chief of Historic Preservation
Mariah McGunigle, HPC Intern & Rosamond H. Rice, Recorder

Prepared 1994 by Dale E. Frens. AIA, and J. Christopher Lang
Frens and Frens, Restoration Architects, West Chester, PA

Acknowledgments

THE MAYOR AND ALDERMEN OF THE CITY OF ANNAPOLIS

DEPARTMENT OF PLANNING AND ZONING

Jon L. Arason, Director
Lisa M. Craig, Chief of Historic Preservation
Shari L. Phippen, Historic Preservation Assistant

ANNAPOLIS HISTORIC PRESERVATION COMMISSION

Sharon Kennedy, Chair
Thomas Bunting, Vice Chairman
Shelley Rentsch • Kim I. Finch • Bronte D. Jones, Ph.D.
Timothy P. Leahy • Shelley Rentsch • Patricia L. Zeno

DESIGN GUIDELINES COMMITTEE

Patricia Blick
Tom Bunting
Dorothy Callahan
Jeffery Halpern
Donna C. Hole
Sharon Kennedy
Rosamond Rice
William Schmickle

EDITORS

Jean B. Russo, Ph.D.

COVER PHOTOGRAPHS

Marion Warren Collection,
Maryland State Archives (*top, center left, bottom right*)
Historic Annapolis Foundation (*center*)
Donna C. Hole (*bottom left*)

GRAPHIC DESIGN

Words & Pictures, Inc.
27 South River Road South
Edgewater, MD 21037

PRINTER

Vision Lithographics
9601 Fallard Terrace
Upper Marlboro, MD 20772

This project was financed in part with Federal funds from the National Park Service, Department of the Interior, made available through the Maryland Historical Trust, an entity within the Department of Planning, State of Maryland, and the City of Annapolis. This Certified Local Government matching grant was administered by the Annapolis Department of Planning and Zoning for the Annapolis Historic Preservation Commission. However, the contents and opinions of this report do not necessarily reflect the views or policies of these agencies. The above-mentioned grant was used to fund the research for this publication.

All vendors, consultants and local officials involved with the project were notified that this project received Federal funds from the National Park Service, and that regulations of the U.S. Department of Interior strictly prohibit unlawful discrimination in departmental Federally Assisted Programs on the basis of race, color, national origin, age and handicap. Any person who believes he or she has been discriminated against in any program, activity or facility operated by a recipient of Federal assistance should write to: Director, Equal Opportunity Program, U.S. Department of the Interior, National Park Service, P.O. Box 37127, Washington, DC 20013-7127.

Table of Contents

CHAPTER 1

Annapolis and Historic Preservation.....	5
--	---

CHAPTER 2

History and Architecture of Annapolis.....	11
Character-Defining Features and Styles in Annapolis.....	16

CHAPTER 3

Designing for the Historic District.....	25
Design Guidelines	33
Sign Guidelines	56
Sidewalk Café Guidelines	70

CHAPTER 4

The Review Process	73
--------------------------	----

APPENDIX A

The Secretary of the Interior’s Standards for Rehabilitation	75
--	----

APPENDIX B

Annapolis Architectural Glossary	76
--	----

APPENDIX C

City of Annapolis Historic District Zoning Ordinance	79
--	----

APPENDIX D

Selected Bibliography	86
-----------------------------	----

INDEX	87
-------------	----

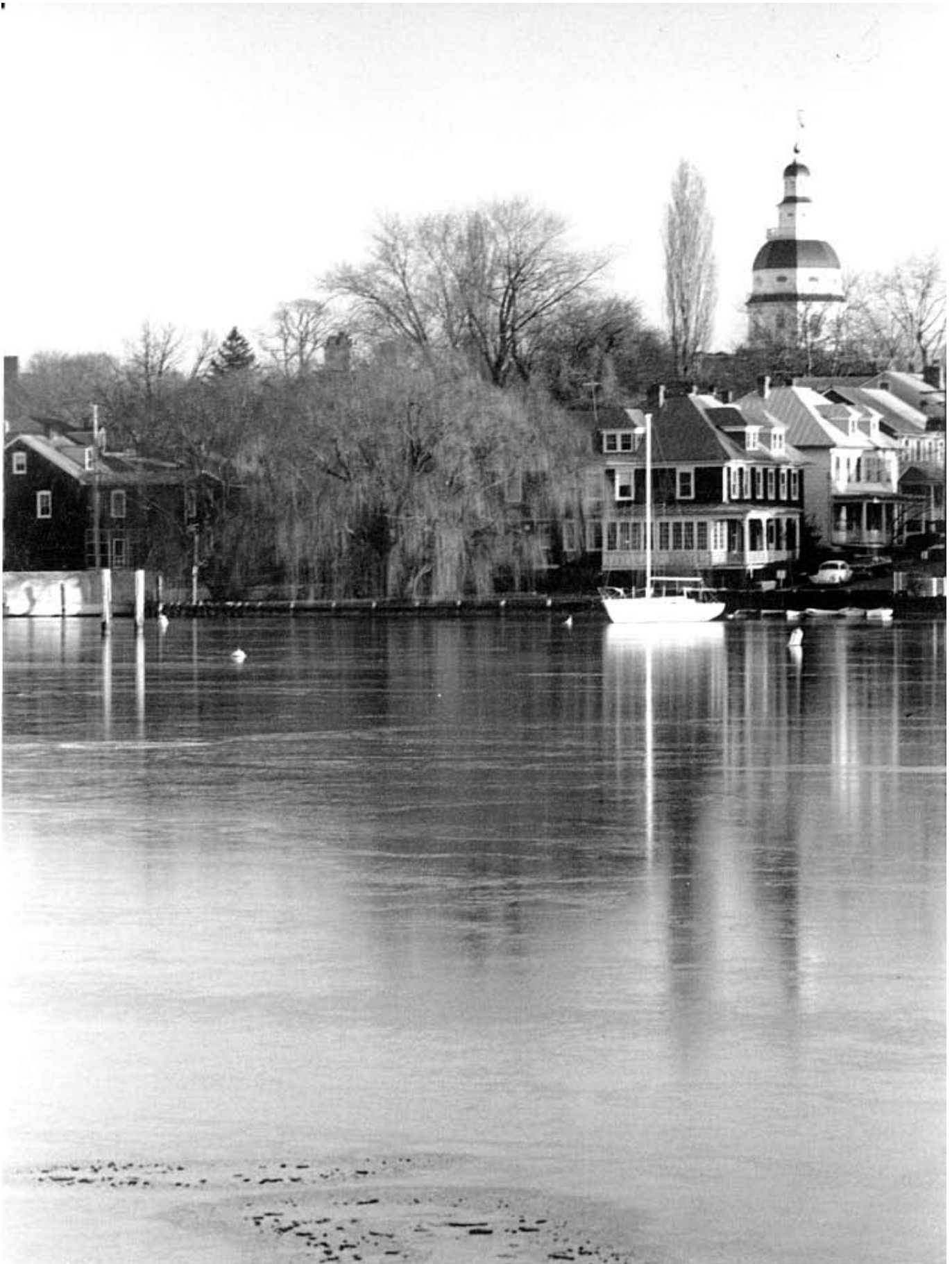

Figure 1. View of Annapolis from Spa Creek. Photograph courtesy of Celia Pearson.

Chapter 1

Annapolis and Historic Preservation

INTRODUCTION

The architectural and historic significance of Annapolis has been recognized both locally and nationally. Based upon its “exceptional value or quality in illustrating or interpreting the heritage of the United States,” the Colonial Annapolis Historic District was designated one of forty-three National Historic Landmark Districts in 1965 by the U.S. Department of the Interior’s National Park Service. In recognition of the superior preservation of its significant eighteenth, nineteenth and early twentieth century structures, an enlarged historic district was placed on the National Register of Historic Places in 1984.

Annapolis is a remarkable urban environment. Laid out 300 years ago on a neck of land where the Severn River joins the Chesapeake Bay, the city evokes a sense of history and a sense of place, expressed in the character of its streets, the fit of its land to the water, and its pleasing human scale. Governor Francis Nicholson’s 1695 town plan for Annapolis is the oldest surviving Baroque plan in the United States. Annapolis presents a unique record of the pre-industrial colonial city in our country, and its collection of 18th, 19th and 20th century architecture is important to the entire nation. Annapolis was home to Maryland’s four signers of the

Declaration of Independence; the Continental Congress met here during 1783 and 1784; and in 1845 the U.S. Congress chose Annapolis as the location for the U.S. Naval Academy.

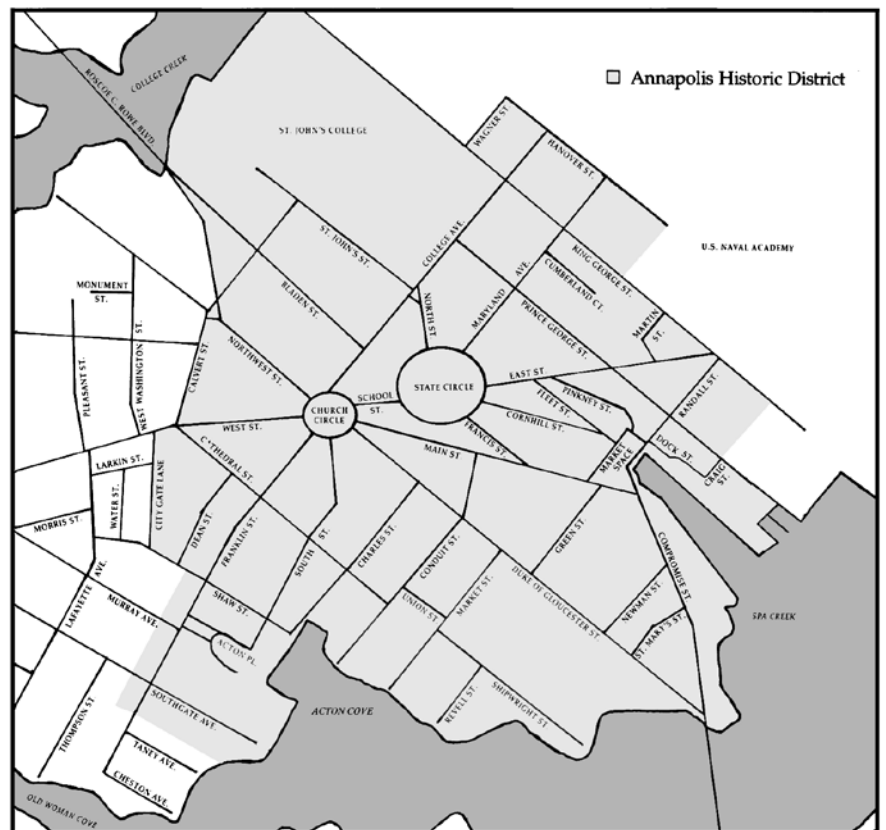

Figure 2. Annapolis Historic District map.



Figure 3. William Paca House, 186 Prince George Street (1763-1765). Left: View from northeast during demolition of Carvel Hall Hotel. Below: Restored garden and facade. (Marion Warren Collection, Maryland State Archives. Left: MSA 1890-2021-3; below: MSA SC 1890-3526 [detail].)



HISTORIC DISTRICT PROTECTION IN ANNAPOLIS

Community Activism

Community efforts to preserve the historic environment of Annapolis extend back to the nineteenth century, although an effective local historic district zoning ordinance was not enacted until 1969. The impact of the protection afforded by historic district zoning and the efforts of the Historic Preservation Commission, Historic Annapolis Foundation, and an assortment of house museum associations, can be seen throughout the district.

In 1952 Historic Annapolis, Inc. was founded as an advocate and agent for preservation in the city. Its charter was “to preserve the distinctive quality of Annapolis and Anne Arundel County derived from the buildings, structures, objects, and spaces that possess integrity of design, setting, materials and workmanship that contribute to the historic character of this locale.” Historic Annapolis’s accomplishments include research on the history of Annapolis and its buildings, and the pioneering of historic preservation easements. Historic Annapolis, Inc. saved the William Paca House from demolition and in partnership with the State of Maryland restored the Georgian house and private garden to their 1765 appearance.

Annapolis citizens have worked steadily to protect the heritage of their city. They have been at the forefront of historic preservation efforts in both public policy and private action, and have set an example recognized nationwide. The degree of preservation in Annapolis today would not exist without the diligent attention

of the City’s Historic District Commission (now the Historic Preservation Commission) to its preservation mandate. Now, in the first decades of the twenty-first century, the Historic District’s challenge is to balance the conservation of its neighborhoods and architecture with the needs of this century. The commercial success of the waterfront area has strengthened the case for preservation in Annapolis, but also threatens to overturn the balance of neighborhood conservation versus commercial development.

Legislation

The legal basis for the Annapolis Historic District regulations regarding archeological compliance, exterior changes and height and bulk, is the State of Maryland Enabling Act for Historic Area Zoning, Article 66B, Zoning and Planning, Section 8.01-8.17, Annotated Code of Maryland, as reflected in the Charter and Code of the City of Annapolis, Chapter 21.56, Historic Preservation. (See Appendix C for full text). Article I of Chapter 21.56 states that the purpose for creating the special Historic Preservation District is to preserve sites, structures, and districts of historical, cultural, archeological or architectural significance together with their appurtenances and environmental settings.

The stated goals of the regulations governing this special district are to:

- Preserve and enhance the quality of life and to safeguard the historical and cultural heritage of Annapolis by preserving sites, structures, or districts which reflect the

elements of the city's cultural, social, economic, political, archeological, or architectural history;

- to strengthen the local economy;
- to stabilize and improve property values in and around such historic areas;
- to foster civic beauty
- to preserve and promote the preservation and appreciation of historic sites, structures and districts for the education and welfare of the citizens of the city.

Local public policy to protect Annapolis started in 1952. Annapolis's first Historic District Ordinance was passed in 1968 and the first commissioners were appointed in 1969. The ordinance states specific goals: "to stabilize and improve property values in the district; to preserve specific buildings or structures which are deemed to be of historic or architectural value; to foster civic beauty; to strengthen the local economy; to

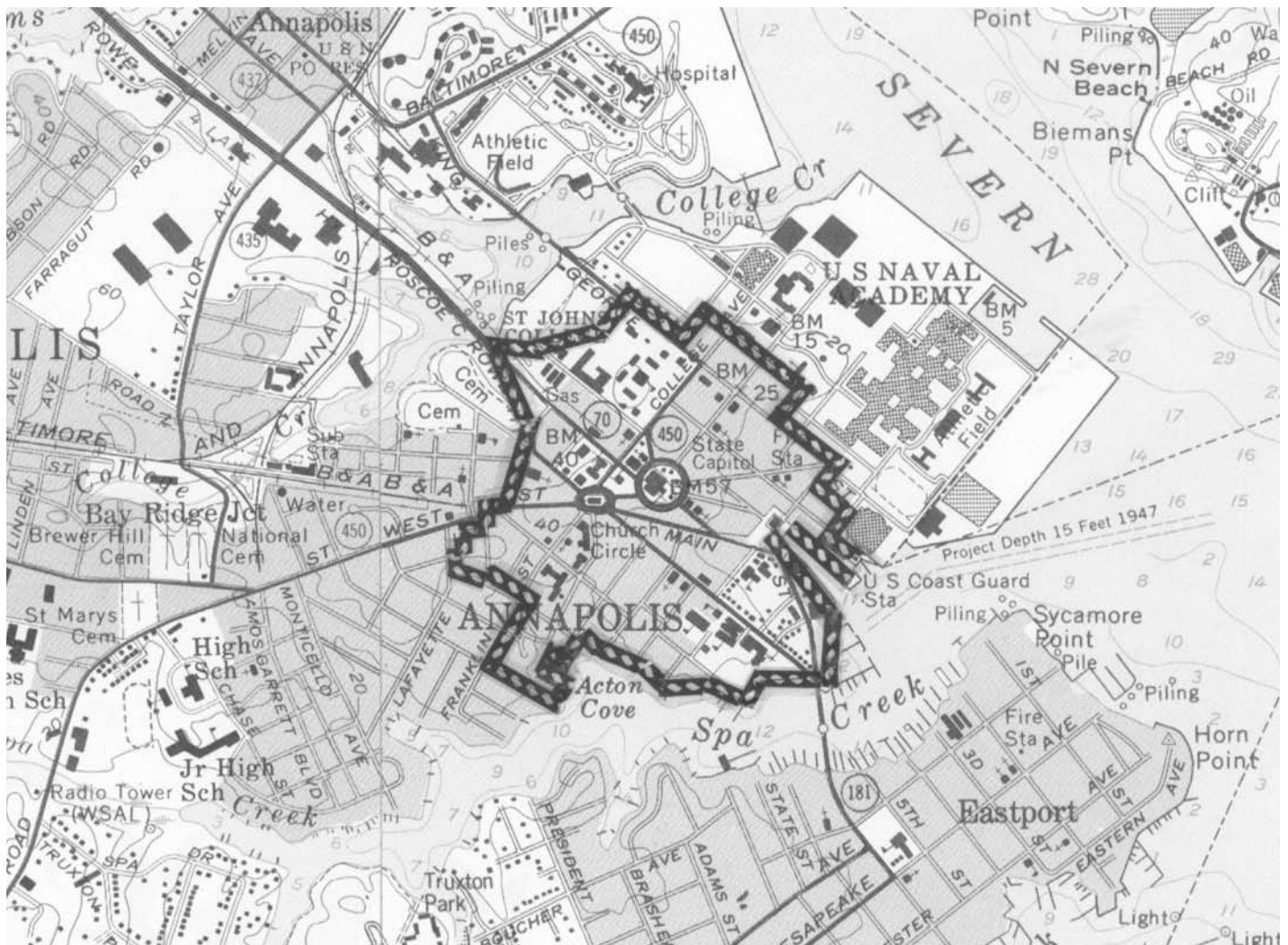

Figure 4. Annapolis Historic District location map. (U.S.C.G. 7.5 Minute Series, Annapolis and South River Quadrangles.)



Figure 5. West Street Comparative views, 1965 and 1977. The Annapolis Urban Renewal Authority repaved West Street, planted street trees, and buried utility lines. Following this public initiative, many building owners restored and reconstructed their building exteriors. (Marion Warren Collection, Maryland State Archives. Left: MSA SC 1890-1693; below: MSA SC 1890-3448.)

promote the use of the district for the education, pleasure and welfare of the citizens.”

That ordinance was revised in 1996, following changes to the state enabling legislation in 1995, with a resulting update to the Annapolis City Code in Chapter 21.56.

Historic Preservation Commission

The existence of a Historic Preservation Commission is required by Section 21.08.060 of the City Code. The Commission’s mandate is to safeguard Annapolis’ heritage as reflected in its three centuries of historic architecture and its broadly visible waterfront. To accomplish this task the HPC is required to review all exterior alterations to property in the historic district, including alterations that cannot be seen from the street or water. This includes restoration, rehabilitation, new construction, renovations, and landscaping as well as replacing building components, such as roofs, doors, windows, porches, railings, and curb cuts. The Commission does not review paint color.

The seven-member Commission is comprised of volunteers who are residents of the City of Annapolis and who possess a demonstrated interest, or professional or academic training, in such fields as history, architecture, architectural history, archeology, anthropology, curation, conservation, landscape architecture, historic preservation, urban design or



other related disciplines. The City’s Planning and Zoning Department provides full-time staff support to the Commission, in the form of the Chief of Historic Preservation and the Preservation Assistant, as well as the expertise of professional archeological and architectural consultants. In addition, the Commission solicits the advice of non-profit advocacy groups, including Historic Annapolis Foundation, and individual citizens to broaden its knowledge and perspective. Appointments to three-year terms are made by the Mayor and confirmed by the City Council. Information on Commissioners and their qualifications can be found on the City of Annapolis web page: http://www.annapolis.gov/government/boards/hist_pres.



Figure 6. Base Map of the Annapolis Historic District, 1989. The density and pattern of development is shown by the shadings of the buildings. The density of development in the commercial areas reinforces the pattern of radiating streets and contrasts with the openness of State Circle and Church Circle.



Figure 7. 86-88 State Circle. (Marion Warren Collection, Maryland State Archives, MSA SC 1890-2897)

Chapter 2

History and Architecture of Annapolis

HISTORICAL DEVELOPMENT OF ANNAPOLIS

Geographical Factors

The geography of the Tidewater region, its mild climate, fertile land and numerous waterways made the Maryland and Virginia coastal plain favorable for a seventeenth century settlement based on an agricultural economy. The vast waterways provided an extensive transportation system, which opened up thousands of acres to agricultural settlement, with tobacco as the staple crop.

Early History

The colony of Maryland was created in 1632 when King Charles I granted a Royal Charter to Lord Baltimore, Cecil Calvert, a Catholic. This charter granted ownership (proprietorship) of all the land and the right to govern the colony to Lord Baltimore and his heirs. This proprietary colony's first settlers arrived in 1634 and established St. Mary's City where the wide mouth of the Potomac River empties into the Chesapeake Bay. The first colonial settlement in the Annapolis region was in 1649 when Puritans from the royal colony of Virginia moved to the Severn River at the invitation of Maryland's governor, to seek greater religious freedom.

By 1683, due to shifts in English policy and the growth of the colony, the Provincial Assembly (then meeting in St. Mary's) enacted a New Towns Act calling for several new towns, especially port towns. This Act specified that "the Towne Land at Proctors," (later to be named Annapolis) be laid out as a town on 100 acres. The acreage was to be "marked, Staked and Divided into convenient streets, lanes, and alleys with other spare places to be left on which may be a Church, Chapel, Market House or other public buildings and the remaining part...to be divided into one hundred equal

lots." Land adjoining was to be fenced in and called the Town common or Pasture. Starting near the end of today's Duke of Gloucester Street, county assistant surveyor Richard Beard laid out streets in a rectangular grid pattern and staked lots along what later became Market and Shipwright Streets.

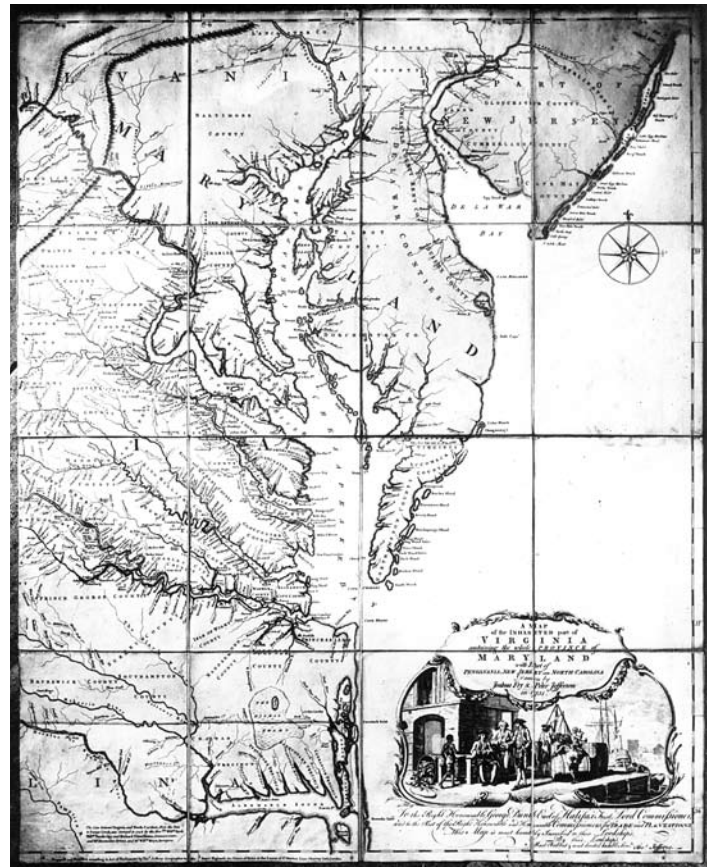

Figure 8. Map of the Chesapeake Bay. Water transportation and a prosperous agricultural economy provided the economic and geographical basis for Annapolis's development as a political and cultural center.

Following the 1688 Glorious Revolution in England, the Catholic King James II was deposed in favor of Protestants William and Mary. In the wake of a subsequent revolt against Lord Baltimore by Protestant settlers, Maryland petitioned for and became a Royal Colony. The Crown governed the colony until 1715, when Charles, fifth Lord Baltimore, conformed to the Church of England and King George I returned political authority to the Calverts.

Anne, next in line of Royal succession, to name the new city after her. An Act of Assembly in 1696 confirmed the choice. Princess Anne, a devout Protestant, became Queen in 1702.

ANNAPOLIS' BAROQUE PLAN

It is Nicholson who is credited with establishing the baroque town plan of Annapolis. He was a world traveler for his time, familiar with cities in Europe and

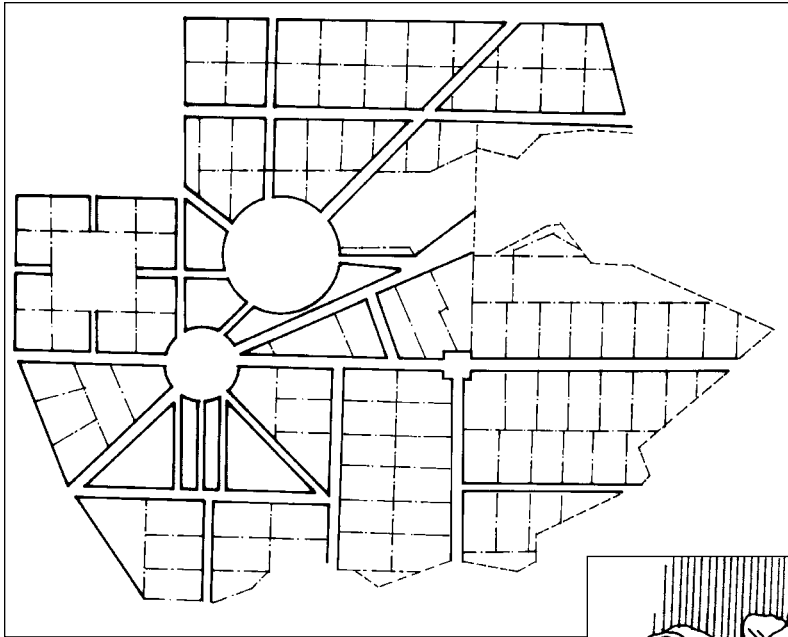

Figure 9 (left). 1696 Baroque Plan of Governor Francis Nicholson.

Figure 10 (below). Map of the original water's edge outline. This generalized topographic map reveals how the urban form was made to fit the natural land form, with the two circles placed on the highest points. The water's edge has been altered by land infill. Note how Main Street follows a valley from Church Circle, and East Street follows a ridge from State Circle.



Francis Nicholson, previously Lieutenant Governor and later Governor of Virginia, was appointed the Royal Governor of Maryland in 1694. Soon afterwards, the Assembly passed two Acts that caused the capital to be relocated from St. Mary's to what was to become Annapolis. The first Act, signed by Nicholson, created two towns, Oxford on the Eastern Shore of the Bay and a second, "Arundell Towne," on the site of "the land called the Town Land at Seavern in Ann Arundel County where the town was formerly." That same year Nicholson, in a subsequent Act designated "Arundell Towne" as "the Chief Place and Seat of Justice within the Province for holding of Assemblies and Provinciall Courts." By these moves, the government accomplished two key objectives: 1) it shifted the seat of government from a Roman Catholic center to a Protestant region, and 2) it established a more central location for the capital. The selected site also possessed the best harbor above the Patuxent River.

The name Annapolis was affixed to the town when Governor Nicholson requested permission from Princess

in North Africa. John Reys, author of *Tidewater Towns* (CWE, 1972), makes the case that Nicholson, formerly of London, was influenced by the rebuilding of London after the Great Fire of 1666 and drew on the principles of town planning that came from Continental Europe.

Town planning in seventeenth century England was greatly influenced by principles of large garden design that originated on the European continent

during the Baroque era. After the London Fire of 1666 destroyed the medieval city, both Christopher Wren and John Evelyn proposed reconstruction plans incorporating diagonal streets terminating in various major open spaces. Nicholson owned copies of Evelyn's recent translation of the large French manual *The Compleat Gardner* (1693) and Evelyn's *Sylva* (1679) which described new principles of landscape design. Evelyn's plan for rebuilding London exhibited sharply intersecting diagonal streets, as well as a variety of urban open spaces and sites for important buildings. He recommended that "not all of them be square, but some of them oblong, circular and oval for their better grace and capacity."

Nicholson's plan for Annapolis incorporates these ideas from England into America's first complete and surviving Baroque urban plan. An application of abstract design principles to the landform, the plan emphasized the highest elevation on the relatively small neck of land. The larger circle for the State House encircled the highest knoll (55 feet above sea level) and a smaller circle for the Church was sited on the slightly lower crest. The 520-foot diameter State Circle contained almost the six acres prescribed by the original town decrees, while the 346 foot diameter Church Circle contained somewhat over two acres. For contrast (and closely following Evelyn's tenets), Nicholson's plan called for "Bloomsbury Square" to be formed by 12 lots north of the Church Circle. From the major focal points, radial streets extended to the cardinal points of the compass. Accommodating the topography prevented a pure geometry. This lack of precision gives



Figure 11. Maryland State House, 1792. (Marion Warren Collection, Maryland State Archives, MSA SC 1890-3044.)

the grand conception a more natural eccentricity, a departure from strict formality. The original Nicholson plan, which set a distinctive town form for Annapolis, continues to define the city's built form.

EARLY BUILDING OF ANNAPOLIS

During the seventeenth century there had been insufficient economic stimulus for settlement in Annapolis. However, the city began to develop when it became the colonial capital in 1694. A two-story brick State House for the Assembly and Courts was completed by 1698, but burned in 1704. The fire resulted in the loss of the original town plan documents and early court records. A second brick structure took its place within three years, and this second structure was replaced by the present State House, built between 1772 and 1788. State Circle was also the site of King William's School, created by Act of Assembly in 1696 and built in 1701 southwest of the State House. This brick structure remained in use until 1789.

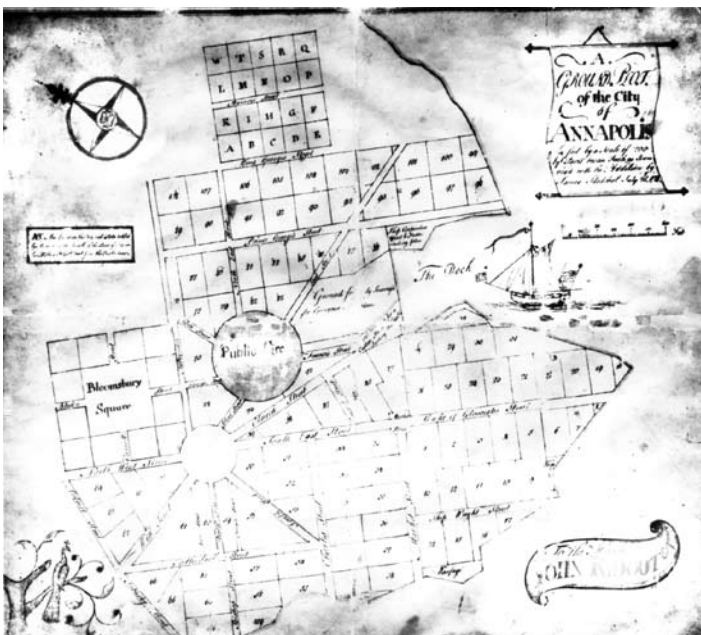

Figure 12. A Ground Plot of the City of Annapolis, by James Stoddert, 1718, copied by James Callahan, 1743. The Stoddert Survey confirmed Nicholson's layout and added the Trade Lots. (Marion Warren Collection, Maryland State Archives, MSA SC 1890-346)



Figure 13. Plan of the Harbour and the City of Annapolis, drawn by Major Capitaine, 1781. This plan reveals the built street pattern and the water's edge prior to major changes in the nineteenth century. (Marion Warren Collection, Maryland State Archives, MSA SC 1890-3502)

After passage of legislation making the Church of England the official religion of the colony, in 1692, work began in 1695 on the first St. Anne's Church, completed by 1706. By 1774 the simple edifice was too small, inconvenient, and in such disrepair that sometime after 1775 it was razed. Plans for rebuilding were delayed by the Revolutionary War and by issues regarding the status of the Church of England. The second St. Anne's was consecrated in 1792. This building burned in 1858, and was replaced by the existing Romanesque structure, begun in 1859 and completed by 1866.

Apart from the "institutional" circles and the other lots set aside for public use, the private Annapolis took form slowly. In 1699 a writer observed:

"Governor Nicholson hath done his endeavour to make a towne... There are in itt about fourty dwelling houses... seven or eight whereof cann afford good lodging and accommodations for strangers. There is alsoe a State house and a free schoole built with bricke which make a great shew among a parcell of wooden houses, and the foundations of a church laid, the only bricke church in Maryland. They have two market daies in the week."

In 1718 a resurvey of the town, necessitated both by the lost courthouse records and title conflicts, was completed by James Stoddert. The survey, drawn from an earlier one by Richard Beard, not only confirmed Nicholson's plan, but supplemented it with ten acres of half-acre lots on the northeast edge of town. The addition, called the Trade Lots, was intended "for the better encouragement of poor tradesmen to come and

inhabit." Expanded in 1725, the site of the Trade Lots now stands within the boundary of the U.S. Naval Academy.

CITY GROWTH

The Maryland colony grew dramatically in the 18th century. The 1675 total colonial population of under 13,000 more than doubled to about 31,000 in 1700; and this in turn increased six fold to 220,000 persons in 1770. Annapolis's population grew as the colony's government grew and as citizens from the colony came to the city to conduct their affairs. Dr. Edward Papenfuse, Maryland State Archivist, has estimated the city had 405 inhabitants in 1715, doubling by 1730, and growing to over 1300 by the Revolution. However, even as late as 1775, a visitor commented that the streets were "extremely hilly and uneven with out a bit of paving."



Figure 14. U.S.C.G. Survey Map, 1844. The extent of the city's development and the location of Fort Severn prior to the creation of the Naval Academy are shown on this map. Note the strong connection of the radiating plan to the water in the area that was to become the Naval Academy. (Marion Warren Collection, Maryland State Archives, MSA SC 1890-352)

An important site for town development was the public market. In Annapolis, the public market shifted its location several times. By 1717 it was located on State Circle, by 1730 it had moved to the harbor, on the so-called Custom House lot, and by 1752 it had returned to State Circle. In 1784, the site of today's Market House was donated to the city and a new structure was built, which was in turn replaced in 1858 by the present Market House. This major community focal point was saved from demolition and restored in 1972.

Two important streets not originally planned were added in the mid-18th century. In 1752 Green Street was

laid out from Duke of Gloucester Street to the dock, and in 1769 Cornhill Street was extended from the State Circle through the Governor's Garden lot to the City Dock. Hyde Alley was created to link Cornhill to Church Street (now Main Street). Only one side of Bloomsbury Square had been developed, and Bladen Street cut through the intended grand residential urban square.

By the 1780s, a superb collection of Georgian houses, as remarkable for their architecture as their urban character, had been completed. The fronts of these homes were set close to the street, allowing space for formal gardens and work areas behind the house, thus maximizing both privacy and utility. In eighteenth century England these houses would have been residences of merchants, squires, clerics and the like, but in Annapolis they represented the colonial version of the monumental town houses of English gentry in London. These houses include the homes of William Paca, John Brice and John Ridout, as well as the Chase-Lloyd House, Hammond-Harwood House, and others. More modest houses, built without side yards and often sharing party walls, completed the urban street space.

By the late eighteenth century, Annapolis faced the necessity of adapting to the evolving economy of a newly formed country. Long term economic growth was inhibited by its shallow harbor, which could not accommodate the larger deeper draft ships of the late eighteenth century. The deep-water harbor of Baltimore City became the focus of the Chesapeake Bay area commercial and industrial expansion. Count La Rochefoucauld visited Annapolis in 1797, and noted: "the population diminishes every year and does not

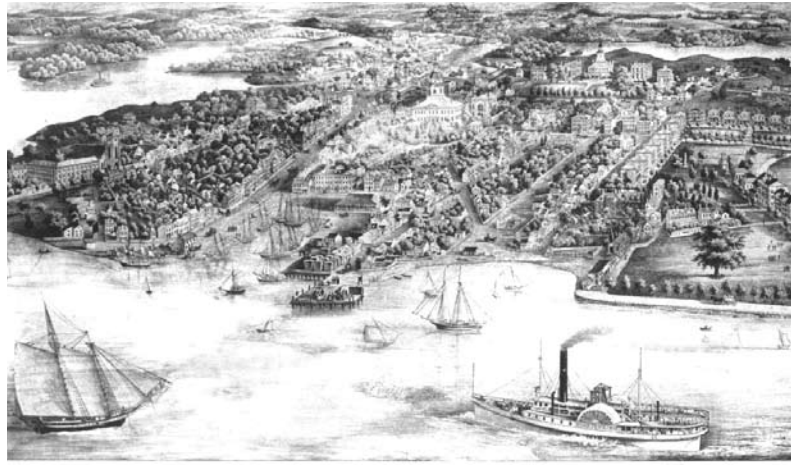

Figure 15. Sachse's Bird's Eye View of the City of Annapolis, 1858. The urbanity of the built environment and the lush vegetation of the location are both revealed in this print. (Marion Warren Collection, Maryland State Archives, MSA SC 1890-379)

contain more than two thousand inhabitants."

The City's financial prospects improved in the mid-nineteenth century with expanded railroad connections which could provide support services for the arrival of the United States Naval Academy. Old Fort Severn on Windmill Point, a military fort dating from the Revolutionary War era, was transferred to the Navy Department in 1845, for use as a training school for officers. Over the last two centuries, the Naval Academy's buildings and coastal alterations have had a profound effect upon the landscape and the Severn River's shoreline. Access to the original Severn Ferry, at the north end of Maryland Avenue, was cut off and the Naval Academy, which encompassed 338 acres, replaced the neighborhood from Hanover Street northeast to the water.

A parallel influence on the city's economy was the extension of a railroad spur into Annapolis, in 1840. The introduction of rail travel improved connections and communication with Washington, D.C. and became the basis for freight shipment servicing the Academy as well. The railroad passenger station was located along inner West Street, the traditional inland link to the

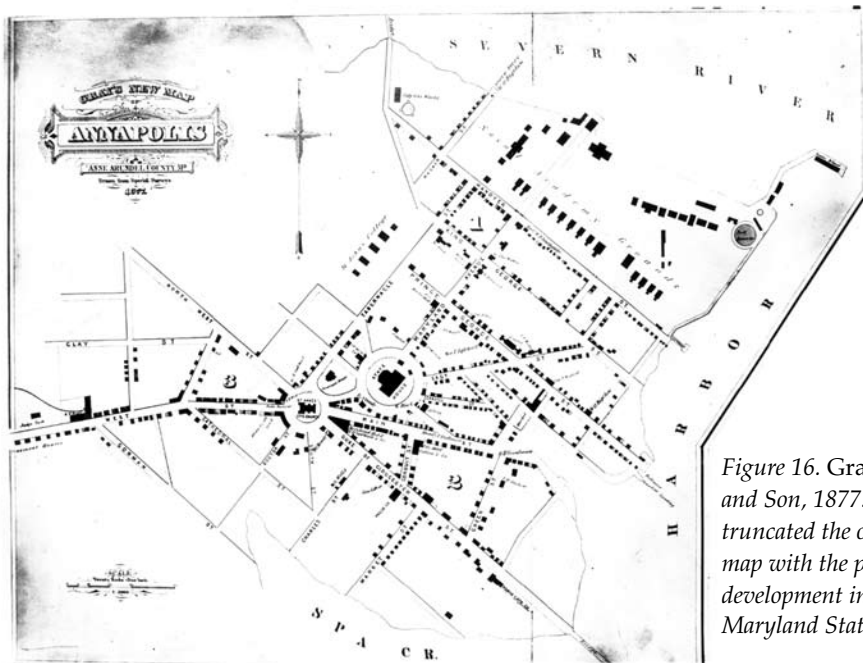

Figure 16. Gray's New Map of Annapolis, by O.W. Gray and Son, 1877. By this date the expanded Naval Academy had truncated the original town plan. A comparison of this map with the present map (Figure 4) reveals the extent of development in the last 135 years. (Marion Warren Collection, Maryland State Archives, MSA SC 1890-3446)

town. In the 1858 “Bird’s Eye View of Annapolis” by E. Sachse and Co., the old city’s fully established pattern at mid-century is clearly seen. The intimate town scale is apparent; the early Academy grounds are visible; and the visual dominance of the State House is clear.

After the Civil War, transportation improved again, encouraging development of areas outside the original town limits. A steamboat landing was constructed at the foot of Prince George Street. After 1868, West Street was no longer the only road leading into the peninsular city. One bridge was built across College Creek and another across Spa Creek, providing additional land routes to the city. By 1885, Martin Street was added and King George

and Randall streets were extended.

In 1890 Compromise Street was extended to connect Main Street to the Spa Creek Bridge when negotiations between waterfront landowners and the city were resolved. Although parts of Compromise Street dated to 1837, it did not extend to the bridge until this late date. This final connection essentially completed the historic area city plan as it appears today.

Except for changes necessitated by demands made on small-scale streets by automobiles and large-scale government office buildings, twentieth century changes to the city’s layout have been minor.

Character-Defining Features and Styles in Annapolis

The historic district possesses a strong urban character formed by the radial city plan, sloping terrain, and numerous water views. Within this unique framework survives an outstanding collection of eighteenth century Georgian houses amidst nineteenth and twentieth

century buildings of diverse styles. For all its diversity, there is a visual unity within the historic district, which results from the human scale of the buildings and streetscapes. It is this unity which the Historic Preservation Commission seeks to preserve.

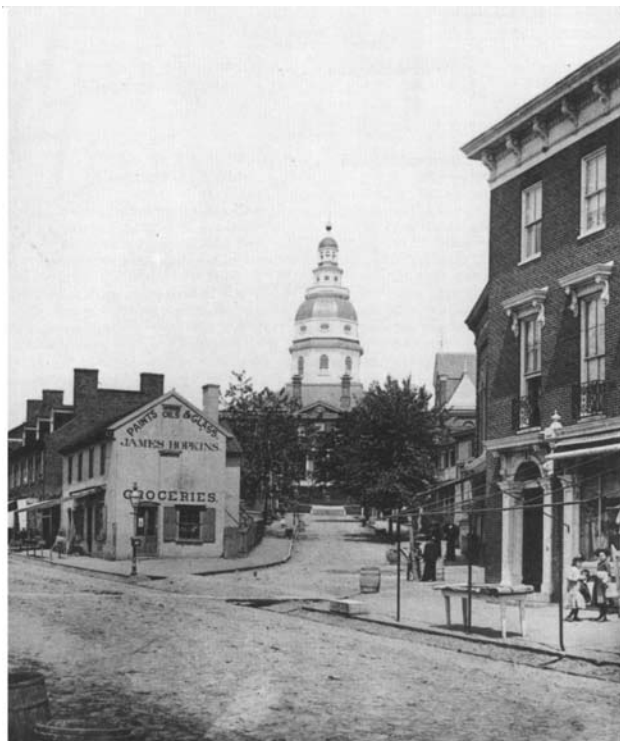

Figure 17. View of intersection of Main Street and Francis Street, 1888-1890. The intersections of radiating streets with rectilinear streets contained in the Nicholson plan created unusual triangular shaped lots, dramatic visual axes and vistas. (Marion Warren Collection, Maryland State Archives, MSA SC 985-65)

CHARACTERISTICS OF ANNAPOLIS STREETS CAPES

Nicholson’s unique plan has survived both in-fill and overlay. Scattered through its eighteenth century town form are over fifty Georgian era structures that represent the city’s golden age. Within this framework, the narrow streets and uniform setbacks are unifying elements. Each building contributes to the closely scaled urban street scheme, with St. Anne’s Church and the State House serving as visual and cultural focal points. The whole is completed by the building facades, which define the streets, and by the open spaces, which provide relief to and focus for the eye.

CHARACTERISTICS OF ANNAPOLIS BUILDINGS

While architecture as a fine art is shaped by the artistic sense, it is bound by the available materials, technology and skills of any given time. Perhaps these limitations are the strongest determinants of the harmonious scale and unity of our older communities, particularly Annapolis. Because of the temperate Tidewater climate, the high water table and the limited materials and technology available to eighteenth century craftsmen, pre-nineteenth century Annapolis buildings share important characteristics. The first floor of most buildings was raised up from the ground on

foundations typically made of stone. Stone is less porous than brick or wood and therefore the most suitable foundation material. A distinctive feature of Annapolis masonry is galleting, the placement of small pebbles or stones in masonry mortar joints, which reduced the amount of mortar required, and provided stability when setting irregular stone. This practice, found in the lowlands of Northern Europe, peaked in England in the early eighteenth century. Galleting was not widespread in the colonies; therefore, its use in Annapolis is a distinctive, character defining feature.

Houses built in Annapolis in the 17th and 18th centuries were modest one-story, wood frame structures with brick chimneys and typical of the Tidewater region. Small houses formed most street edges, separate or attached, ranging from 18-22 feet in width. This typical house width related to the practical limit for an efficient span for wooden floor joists. Larger houses were limited similarly by the practical spanning distance for wood members, and their dimensions represent multiples of such modules.

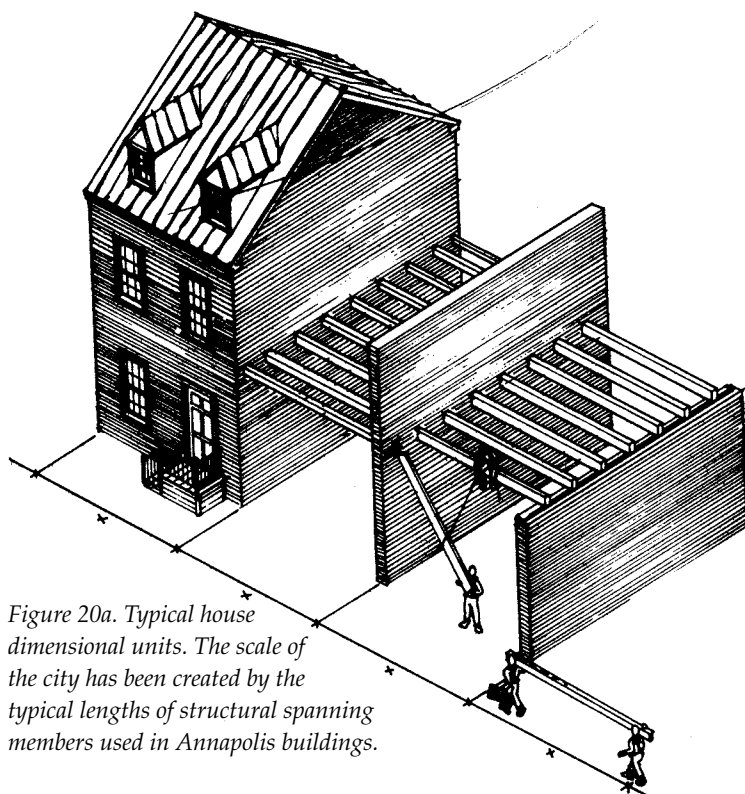

Figure 20a. Typical house dimensional units. The scale of the city has been created by the typical lengths of structural spanning members used in Annapolis buildings.

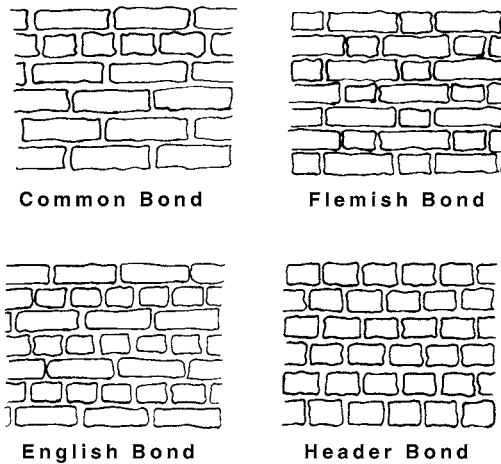

Figure 18 (above). Detail of galleting, William Paca House.

Figure 19 (left). Brick bond types employed in Annapolis. The all-header bond is a distinctive Maryland bond type.

The significant public structures were constructed of brick because of its fire resistance, as were the great houses built from the 1740s to the 1770s. Production of bricks and bricklaying in 18th century Annapolis were highly skilled trades. Brick work in the colonies was laid predominantly in either English bond, having alternating courses of stretchers (long sides) and headers (ends), or Flemish bond, having in each course alternating stretchers and headers. Walls of header bond (all ends facing out), are almost unique to Maryland, and particularly to Annapolis and Chestertown.

STYLES OF ANNAPOLIS ARCHITECTURE

Architectural "style" refers to the manner or mode of building practice at one period of time or in a particular region during that period. Style is distinguished by certain characteristics of design, construction and ornament. Annapolis contains a diversity of styles which reveal a chronology of the city's development and also indicate information about the city's economic life. For example, in Annapolis the Greek Revival style is not well represented because in the early nineteenth century, when the Greek Revival style was fashionable, the city was in a period of economic decline.

One of the most commonly used terms in describing architectural styles is vernacular, which refers to commonplace structures built without formal plans, in the local tradition, using local materials. While the State House and houses of the second half of the 18th century reflect the Georgian style, most of the 18th century buildings in Annapolis are Chesapeake Tidewater vernacular.



Figure 20b. Shiplap House, 18 Pinkney Street, c. 1715. The steep roof, mix of three types of siding, small windows, and single pile floor plan are characteristic of early eighteenth century vernacular dwellings in Annapolis. (Marion Warren Collection, Maryland State Archives, MSA SC 1890-243)

Colonial Vernacular

Early eighteenth century vernacular structures illustrate the transition from post-medieval forms to Georgian style architecture. These buildings are either brick or frame construction with gambrel or gable roofs. The steep pitch of some gable roofs is a direct holdover from the earlier post-medieval emphasis on verticality. These early vernacular structures are single pile in plan (one room deep) with doors and windows placed where

needed with little regard for appearance. Gable-end chimneys predominate in Annapolis. Occasionally, chimneys were incorporated into brick end-walls on frame houses. As the 18th century progressed, some vernacular houses began to adopt elements of the emerging Georgian style, particularly the symmetrical façade. One good example of this adaptation is the Judge John Brice House on Prince George Street.

Examples:

- Shiplap House (c. 1715), 18 Pinkney Street
- Charles Carroll (Barrister) House (1724), St John's College Campus
- Patrick Creagh House (c. 1737), 160 Prince George Street
- Hohne/Slicer House (c. 1770) 45 Fleet Street

Georgian Style

The Georgian style in architecture is named for the era in which it flourished: the reigns of the first three Georges in England (from 1714 to 1820). The primary influence on Georgian design was the work of 16th century Italian master Andrea Palladio. Palladio's designs employed geometric proportions and organizing principles derived from ancient Roman structures and the work of Roman architect Vitruvius, whose *De Architectura* was first published in England in 1715.

In Maryland architecture, the Georgian style is best illustrated in buildings constructed between 1740 and 1784 (the end of the Colonial era). The American version of the Georgian style reflects the English interpretation of Italian Renaissance architecture which, in turn, was based on classical Roman architecture. In the colonies, as in England, the Georgian style is characterized by the rigid symmetry used in the placement of doors and windows in the front facade and the use of classical elements such as columns, pediments, and richly carved and molded cornices. Also evident are fine brickwork, including belt courses, molded water tables, rubbed and gauged jack arches.



Figure 21 (above). Jonas Green House, 124 Charles Street, before 1735. This small scaled Georgian house portrays Georgian principles of symmetrical balance and horizontality. (Marion Warren Collection, Maryland State Archives, MSA SC 1890-244)



Figure 22 (right). Upton Scott House, 4 Shipwright Street, c. 1765, rear view. (Maryland State Archives Special Collections, MSA SC 2545-3741)

After 1750, affluent Annapolis residents had access to pattern and design books published in London by architects and builders, including some based on Palladian design principles. Local buildings in the Georgian style feature some uniform characteristics such as being two-and-a-half or three stories tall, having main entrances centered on the front facade with window and doors evenly spaced, a double-pile plan (two rooms deep) and five or seven bays wide. Beyond this uniformity, however, there are differences.

Some of the large 18th century houses in Annapolis can be termed Provincial Georgian. These are the houses with steep gable roofs, massive end chimneys, brick walls laid in header bond and a lack of sophistication in the handling of the classical elements. Ridout House (1763), the William Paca House (1763) and the James



Figure 24. William Paca House, 186 Prince George Street, 1763-1765. The Paca House was the first of the Palladian great houses constructed during Annapolis' "Golden Age." (Marion Warren Collection, Maryland State Archives, MSA SC 1890-3590)

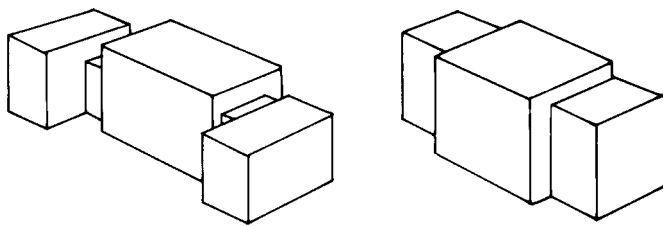

Figure 23. Palladian Five-Part Plan. Andrea Palladio (1580-1640) developed a five-part plan organization for country houses consisting of a central block connected by hyphens to symmetrical dependencies. Palladian houses were fashionable in eighteenth century England and its North American colonies. A simplified three-part plan was also employed, for example, at the Upton Scott House (figure 22).

Brice House (1767) are examples of Provincial Georgian, although the latter two also exhibit the Palladian-inspired formal five-part plan usually associated with high-style Georgian architecture.

High-style Georgian houses are those that have a lower hip roof, less prominent chimneys placed on the interior, Flemish bond, molded brick water tables, central, pedimented pavilions and richly carved moldings. The header bond used in the Upton Scott House (1762-63) and the elaborate door surround and Palladian/Venetian window on the garden façade of the Chase-Lloyd House (1769) are both excellent examples.

Palladian Georgian is the grandest expression of the Georgian style. Derived from Palladio's published designs for Italian villas, elements of this style were used widely in Tidewater Maryland and Virginia. These houses are high-style Georgian with a five-part plan, which is a symmetrical ensemble consisting of a five-bay central block connected by closed passages (hyphens) to two-story wings. The Hammond-Harwood House (1774) is the premier example of this style in the United States.

Federal Style

The Federal period, 1789-1830, was a time of great urban growth in eastern seaboard cities; the Federal style is frequently associated with this growth. However, after the Revolution, Annapolis continued to build modestly in the familiar Georgian forms reflecting a conservative tradition. Examples of the urban Federal architecture do not appear until the late 1840s and 1850s when the Naval Academy brought economic growth. The style is characterized by more slender, graceful forms. Windows exhibit narrow

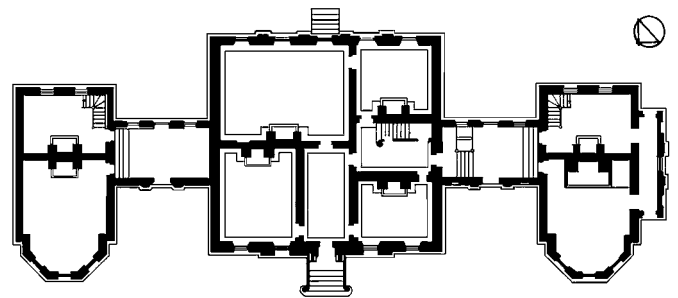
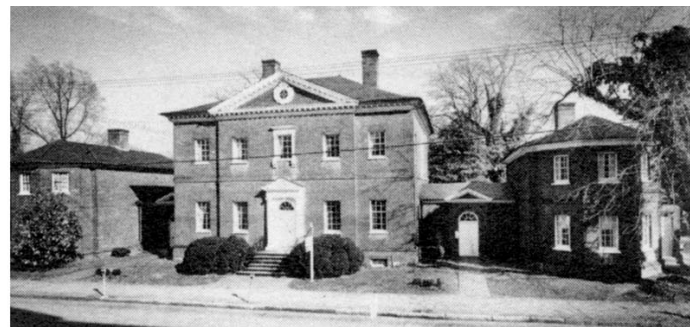

Figure 25. Hammond-Harwood House, 19 Maryland Avenue, 1774. Designed by William Buckland, this high Georgian mansion features strict exterior symmetry and elegant carved wood details. (Plan courtesy of Hammond-Harwood House; photo, Marion Warren Collection, Maryland State Archives, MSA SC 1890-2784-2)



Figure 26. Federal style shop, 109 Main Street, about 1800. Because of the economic change after the Revolution, few Federal style buildings were constructed in Annapolis. (Marion Warren Collection, Maryland State Archives, MSA SC 1890-2900)



Figure 27. Law Office, 17 State Circle, 1850. An example of Greek Revival architecture in miniature. (Marion Warren Collection, Maryland State Archives, MSA SC 1890-3451)

proportions, with larger panes of glass and thinner muntins than those on Georgian windows. Elliptical fanlights and sidelights at doorways featured delicate tracery. Flemish bond masonry joints are refined to pencil line thinness.

After 1830, America's interest in diverse styles produced a broad range of designs, including those from European architecture, which were adapted for the American lexicon to create new forms of expression appropriate to different types of buildings. These include buildings in the Greek Revival, Gothic Revival, Romanesque, Italianate, and French Second Empire styles.

Greek Revival, 1825-1860

The Greek Revival style was typified by the temple form, which put a building's principal elevation at the gable end. Using the rules of the Doric, Ionic, or Corinthian orders, builders followed carpenters' manuals and builders' guides to proportion and detail new buildings.

The fully developed temple front, which is the purest application of the style, was not employed in Annapolis. Instead, the temple form was abstracted and followed in proportion and scale.

In Annapolis the Greek revival style appears mainly in the form of post and lintel door surrounds. One unique example, which demonstrates that the sense of monumental dignity can be realized in miniature, is the Franklin Law Office, 17 State Circle (circa 1850).

Gothic Revival, 1840-1890

Unlike most architectural styles, the Gothic Revival had its origin in romantic literature. Medieval detailing such as steep roofs, pointed arch openings, buttresses and crenellated parapets were characteristic of Gothic Revival detailing. In Annapolis, the style was featured in ecclesiastical structures where the verticality of the style was fully developed in the form of church spires. Two examples of Gothic Revival ecclesiastical architecture are:

St. Mary's Church (1858), 7 Duke of Gloucester Street

Mount Moriah Church/Banneker-Douglass Museum (1874), 84 Franklin Street

Romanesque Revival, 1850-1890

Romanesque Revival architecture is identified by its use of the semi-circular arch for window and door openings. Walls are masonry and facades are often flanked by square or polygonal towers of differing heights. The one full-form example of the early Romanesque Revival is St. Anne's Church (Figure 29). This Lombard Romanesque form of bold, rounded arches and broad wall surfaces was chosen for the 1859 reconstruction of St. Anne's Church on its original 18th century foundation.



Figure 28. Greek Revival Commercial Building, 206 Main Street, about 1840. The temple form of the Greek Revival style is abstracted to a simple gable end with simple pilasters and lunette attic windows. (Marion Warren Collection, Maryland State Archives, MSA SC 1890-3506)

Italianate, 1850-1900

The most predominant Victorian revival style in Annapolis, seen here in many variations, is the Italianate style. This style is identified easily by heavy wooden brackets that support a deep overhanging cornice. The wide overhanging cornices, with their machine-cut brackets, were well suited to row house design, often continuing from row house to row house, forming a continuous horizontal element along the top of the row house walls. The flat facades of typical row houses refer to the urban palaces of Italian Renaissance cities. Projecting bay windows, oriels, and door hoods were applied to punctuate flat wall surfaces. Since all such features were usually mass-produced and available locally, the Italianate style was used commonly for commercial structures, for economic reasons. An example of a free standing, more elaborate form of this style is 243 Prince George Street.

French Second Empire, 1865-1890

The French Second Empire emulated forms developed during Napoleon III's reign (1852-1870). The primary feature of American versions of this robust style was the mansard roof, which makes full use of the attic space by wrapping it with a short, steep, vertical or curved hip roof, capped by a flat or near-flat central roof. Sizable window panes provide air and light to the attic.

French Second Empire structures sometimes used the general vertical proportions of the Italianate style and the larger windowpanes available after the Civil War, notably 2-over-2 double-hung sash.

Figure 29a. The Gothic Revival style St. Mary's Church, Duke of Gloucester Street. (From Historic Annapolis Foundation, A Guide to Domestic and Commercial Architecture Styles in Annapolis, 1975)

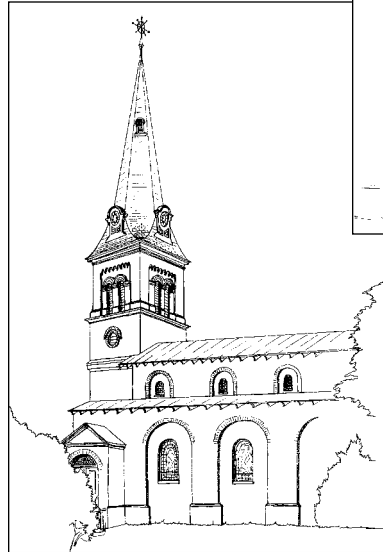
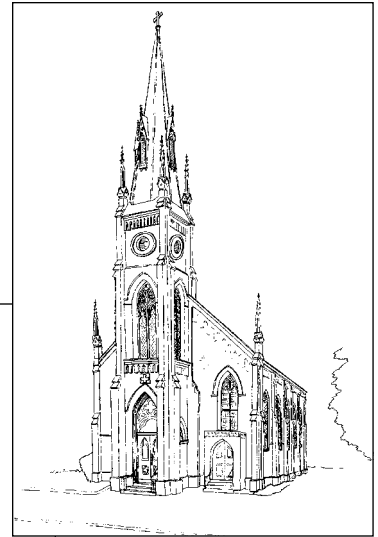

Figure 29b. The Romanesque Revival style St. Anne's Church, Church Circle, 1859. (From Historic Annapolis Foundation, A Guide to Domestic and Commercial Architecture Styles in Annapolis, 1975)



Figure 30. Italianate facade with bracketed cornice, 118 Main Street, 1888-95. During the second half of the nineteenth century, the vitality of commercial enterprise was expressed in the decoration of street facades. Bracketed cornices, door and window hoods, and elaborate storefronts embellished new and remodeled structures. (Mame Warren Collection, Maryland State Archives, MSA SC 985-112)



Figure 31. Maryland Inn, Duke of Gloucester Street and Main Street at Church Circle, 1784, Mansard roof added 1868. Above: Watercolor of Maryland House, c. 1794. Right: Maryland Inn after 1868 additions, including a Mansard roof and porches. (Watercolor by permission of the Hammond-Harwood House Association, Inc., State House Graphics Collection, Maryland State Archives, MSA SC 1556-10; photograph: Marion Warren Collection, Maryland State Archives, MSA SC 1890-2792)

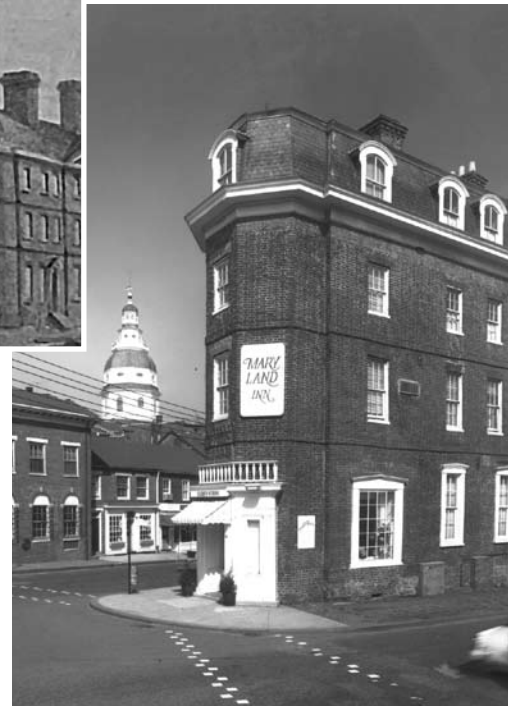



Figure 32. The Zimmerman House, 138 Conduit Street, c. 1895. The exuberance of the Queen Anne Revival style is exemplified in this picturesque residence. Professor Charles A. Zimmerman, builder of the house and bandmaster at the Naval Academy, composed "Anchors Aweigh" during his residence here. (Marion Warren Collection, Maryland State Archives, MSA SC 1890-2990)

Buildings were decorated with brackets and other ornamental forms cut out of flat wood. The French Second Empire style became popular in Annapolis for both residential and commercial buildings and it was even used to modernize the appearance of earlier structures, such as the Maryland Inn. The Maryland Inn was originally built in 1784 but was expanded upward and ornamented after 1868. The Governor's Mansion, built in 1866 on State Circle, was originally French Second Empire style and remodeled in 1935 in the Neo-Georgian style (see next page).

Queen Anne Revival, 1875-1890

The Queen Anne Style originated in England with the architect Richard Shaw, in 1868. Irregularity of plan, massing and use of various textures are features of this style. Early English examples were built of brick and stucco with terra-cotta tiles or wood shingles hung on wall surfaces. Slate roofs with terra cotta cresting, cross gables, paneled, stacked chimneys, turrets and towers all contribute to the Queen Anne style.

The duplex at 88 State Circle, 1878, (see pages 10 and 29) is a good local example of the early English Queen Anne style. Later the style was often interpreted in wood, which was manipulated with great exuberance and without restraint to create a picturesque effect, as in the Zimmerman House (1893).

Shingle, 1880-1900

The Shingle style is an indigenous American style, which unified early traditional house shapes into a balanced and picturesque silhouette wrapped with the warm texture of wood shingles. The Shingle style was at first used widely for informal, summer houses with porches inset within the overall building mass. An example of the Shingle style in Annapolis is 61 Franklin Street (1903).

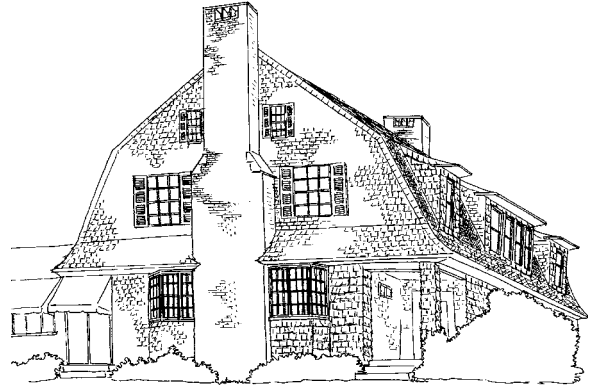

Figure 33. 61 Franklin Street, 1903. Shingle style houses often were based on colonial buildings; walls and roofs were finished with shingles. (From Historic Annapolis Foundation, A Guide to Domestic and Commercial Architecture Styles in Annapolis, 1975)

Late 19th & early 20th Century Revivals, 1895-1930

After the 1876 Centennial celebration, American architects began to use over-scaled colonial forms and details in their Queen Anne and Shingle style compositions, and to design complete Colonial Revival interpretations. Effect was often more important than correctness in the Colonial Revival houses of the turn of the 20th century. Porches, complex floor plans, and over-scaled windows were all accommodated. An example of the Colonial Revival is 59 Franklin Street.



Figure 34. 59 Franklin Street. The Colonial Revival style, which grew out of the 1876 Centennial Exhibition, has proven to be one of the most long-lived architectural styles in Annapolis. (From Historic Annapolis Foundation, A Guide to Domestic and Commercial Architecture Styles in Annapolis, 1975)



Figure 35. The Governor's Mansion (Government House), State Circle, was built in 1866 in the French Second Empire style (left) and remodeled in 1935 in the Neo-Georgian style (below). (left: The Annapolis I Remember Collection, Maryland State Archives, MSA SC 2140-304; below: Marion Warren Collection, Maryland State Archives, MSA SC 1890-2474)



In the twentieth century, with architects better equipped with academic studies and their clients more conscious of historically correct forms, the Colonial Revival style included more literal copies of colonial Georgian structures. Because of the marvelous Georgian examples in Annapolis, the local Georgian Revival style carefully recreated early local details. For example, the 1870 French Second Empire style Governor's Mansion, on State Circle, when remodeled in 1935, was transformed to the outward expression of its local Georgian predecessors.

Modern Movement

Following the structured, anti-revivalist style of the Bauhaus and other European movements, as well as the American designs of Frank Lloyd Wright and others, the International style emerged in the 1930s. The International style has evolved into what today is called Modern Architecture. While the term "modern" has been used repeatedly in design history, it has come to represent a style of twentieth century architecture characterized by abstract facade designs, extensive use of glass and metal as facade materials, lack of ornamentation or small detailing, frequently complex massing, exterior expression of the interior function, expression of structural or massing elements, and new materials.

Many twentieth century Modern buildings lack human scale. While Annapolis has some successful modern in-fill buildings, others are disruptive to their historic contexts. Two good examples of the Modern Movement can be seen at 6 Cumberland Court, the Reverend J. Winfrey Smith House, and Mellon Hall at St. John's College. In Annapolis, most modern design is seen in remodeled storefronts on major retailing streets. Modern storefronts featuring large sheets of glass, sidewalk-level access to building interiors, and aluminum doors and window frames have replaced many historic storefronts in Annapolis.

Post-Modern Style

The current "post-modern" style in the United States is characterized by its use of abstracted historical forms and design elements, and is represented in Annapolis. First conceived as a protest to the abstract and banal quality of modern architecture, the post modern style began as a search for a design vocabulary which would relate new buildings to their contexts, so as to be of a more human scale. Post-modernism has developed now its own set of design elements, such as cross gables, arched windows and dormers, often employed as a formula without reference to context.

New construction in the historic district will have to be based on a careful mix that respects the existing scale, material and fenestration, while clearly representing 21st century design.



Figure 36. 6 Cumberland Court, the Rev. J. Winfrey Smith house. (Photograph courtesy of Donna C. Hole)



Figure 37. Upton Scott House, 4 Shipwright Street, 1762-63. The Upton Scott House was described as “the best town house in America” by Daniel Dulany shortly after its completion. (Willie Graham, Colonial Williamsburg Foundation, 1996)

Chapter 3

Designing for the Historic District

CONCEPTS AND PRINCIPLES OF HISTORIC ARCHITECTURE

Introduction

Architectural styles alone do not provide enough information about buildings to be used as a basis for evaluating proposed changes to existing buildings and proposed new buildings. Evaluation through the application of the design principles of historic architecture is a more precise and more descriptive method of considering the appropriateness of proposed changes. Design principles provide a vocabulary for evaluating new buildings within an existing historic context. It is not the goal of the historic district ordinance to encourage new buildings to copy historic styles. To the contrary, the ordinance encourages good contemporary design which follows the design principles of existing neighboring buildings, and respects the scale, proportions, order, rhythms, and materials of the prevailing historic context.

Historically, stylistic features were an integral part of original building design. Over time, stylistic features were applied to alter the appearance of the building shell. For example, a block of brick row houses may feature examples of more than one architectural style and yet remain a very homogeneous group by the consistent use of architectural design principles. The common building scale and proportions, the facade material, the rhythms provided by window and door openings, and the constant cornice height make the differences in architectural styles a secondary consideration.

Scale

Scale may be thought of as the relationship of the parts to a whole. Scale in architecture is a measure of the relative or apparent size of a building or building component in relation to a known unit of measure or a familiar size for such a component. A building is of human scale when the size of architectural components relates to the size of an adult human body.



Figure 38. Cornhill Street, 1990. Although several architectural styles are represented in this streetscape, the overall character of the row is one of architectural harmony. The common building scale and proportions, facade materials, the rhythms provided by window and door openings, and the constant cornice heights make the differences in architectural styles unimportant. (Marion Warren Collection, Maryland State Archives, MSA SC 1890-3265)

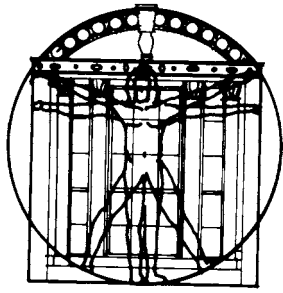
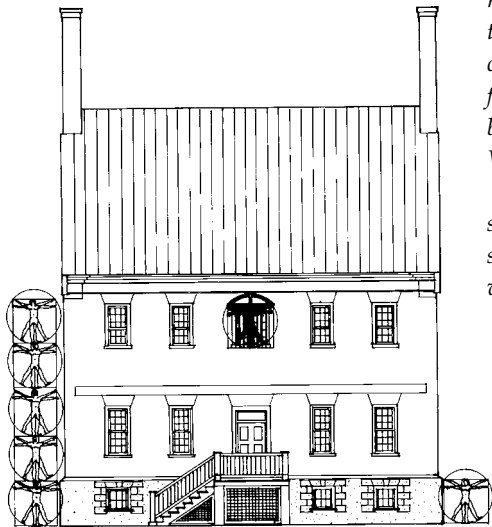

Figure 39. Front elevation of the center block of the James Brice House, begun 1767. The scale of this facade relates to the dimensions of the human body. Note the close



relationship of the circle of the classic Vitruvian figure drawn by Leonardo da Vinci (simplified) to the arched surround of the second story hall window.

A building may be said to be of residential scale when its architectural components, such as doors, windows, and rooms, are of sizes typically encountered in buildings where people dwell. Building components, such as familiar size doors and windows, are said to be scale-giving elements which can be used as visual measuring devices in their context. Scale is perhaps the most important design principle to be considered in evaluating proposed new construction in historic neighborhoods.

The principle of scale applies both to individual buildings and to streetscapes. In an urban setting, where each building functions as a part of the larger streetscape, building scale is of paramount importance. The scale of any proposed building relative to the size of adjacent “building units” is both an issue of 1) dimension, i.e. the overall size of the proposed building mass compared to existing buildings, and 2) the visual relationship of windows and doors of an individual

building relative to the same components on its historic or contemporary neighbors.

Outdoor spaces, including streetscapes, possess scale as well. The walls of buildings, hedges, fences, and outbuildings create outdoor spaces where scale is created by the height and spacing of buildings, the width of the street, and landscape elements. The intimate scale of Annapolis streetscapes is formed by the residential scale of buildings, the width of the street, the placement of buildings on their lots, the human scale of building features such as railings, porches, windows, shutters, doors, and the presence of trees and shrubs.

An institutional or commercial building newly constructed within an existing residential neighborhood may be described as having a neighborhood scale if its overall size is similar to typical neighboring residences, or if the whole is broken down into building elements that are similar to its neighbors.

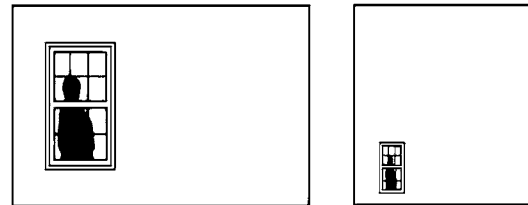

Figure 40. Building components such as windows are scale-giving elements which can be used as visual measuring devices. The left facade appears to be a one-room, one-story building, while the right facade appears to be a multi-room, three-story building.

The architectural diversity of Annapolis streets is visually pleasing because within the differences in styles there remains a harmony of scale. This harmony is enhanced through the use of common building materials. These materials—bricks, clapboards, shingles, window panes—are made of natural materials and use traditional construction methods. The harmony is further enhanced when these materials are used in units which are of a human scale.

The contrast in scale formed by 18th century great houses standing in a setting of more modest dwellings reveals the social order of the pre-industrial city, where homes of the wealthy were distinguished by size rather than by being segregated into prestigious enclaves. The mix of large and small dwellings is one of the most significant qualities of the Annapolis streetscape.



YES The scale of a large new building is broken down to relate to the context of detached dwellings.

NO The new garage building is out of scale in its context of detached dwellings.

Figure 41. Sketch of a simplified streetfront. A large building planned within an existing residential neighborhood may be given a residential scale by breaking down its mass into building blocks (building elements) that are the same scale as neighboring buildings.

Figure 43. Georgian house dependencies make a transition between the large central blocks of the great houses and the neighboring nineteenth century infill buildings. On the left is the Paca House right dependency; on the far right is the Brice House left dependency. The mix of large and small scale dwellings is one of the most significant qualities of the Annapolis streetscape.



Figure 42. The common brick, handmade in the eighteenth century, is scaled to the human hand.

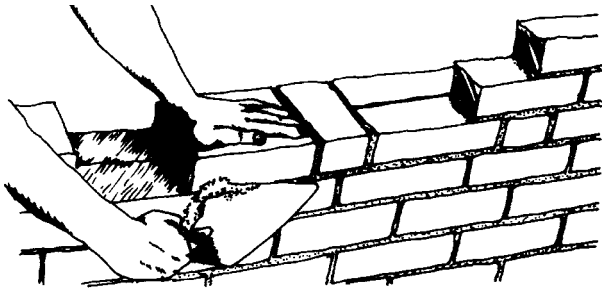

Conversely, in the commercial, governmental, and institutional areas of the district, new large buildings for modern functions intrude upon the historic setting. Because newer buildings tend to be larger, the significance of the size of the State House and the churches is diminished. As more and more large buildings are constructed, the diversity in scale that these historic public buildings once provided is diminished.

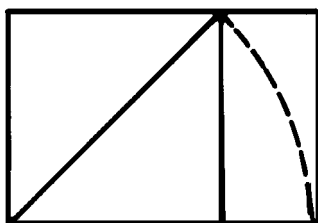
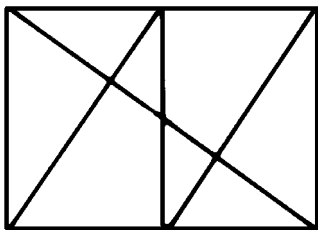

Figure 44. Top: Geometrical system of proportion; Bottom: The Golden Section.

Proportion

Proportion in architecture deals with the comparative relationships among parts, with respect to size and ratio of dimensions. Our visual sense of proportion derives from the Renaissance:

“The purpose of proportion is to establish harmony throughout a structure—a harmony which is made comprehensible either by the conspicuous use of one or more of the orders as dominant components or else simply by the use of dimensions involving the repetition of simple ratios.” (John Summerson, *The Classical Language of Architecture*, Cambridge, MA: MIT Press, 1963, p. 8).

Thus, in a well-proportioned building the parts of the building are arranged in a harmonious and balanced way. Numerous proportioning systems exist in western architecture, all devised with the intent of creating a

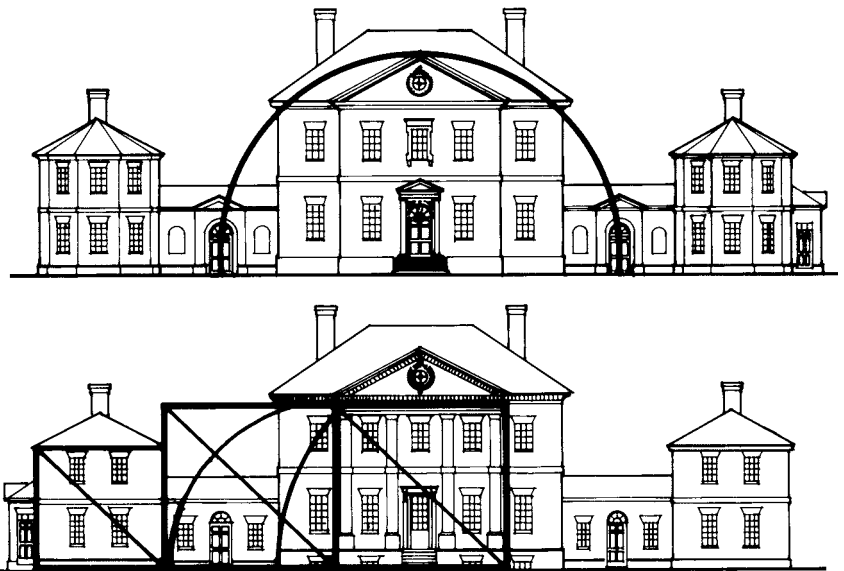

Figure 45. Proportioned study of the street and garden facades of the Hammond-Harwood House. The carefully proportioned facades of this Georgian masterpiece reflect the Renaissance preference for elemental geometric shapes such as squares and circles. (Base drawing courtesy of the Hammond-Harwood House.)

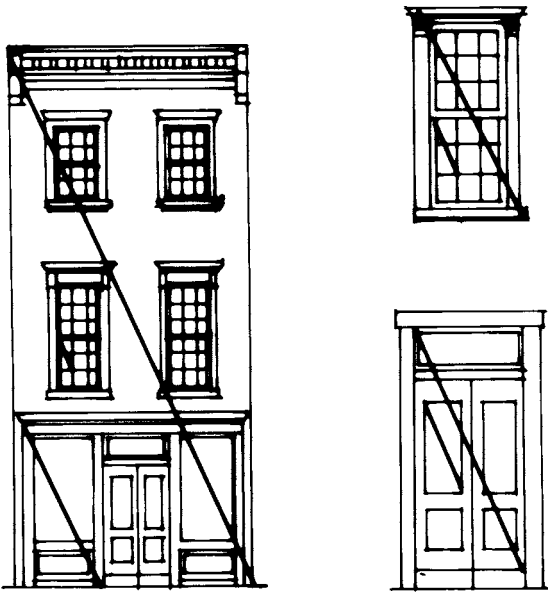

Figure 46. Reconstruction drawing of nineteenth century commercial building. The vertical proportions of the facade are repeated in the proportions of the doors, windows, and window panes. (Base drawing courtesy of Historic Annapolis Foundation.)

sense of order among elements in a visual composition, and all based on the principle that certain mathematical relationships express harmony. The most well-known system of proportion is the Golden Section, which dates from classical Greece and was thought to embody the proportions of the human body (see page 27, figure 44).

From the sixteenth century to the nineteenth century, there was a consensus in architecture that the parts should correspond to the whole and to each other. Such reasoning required planning prior to construction. As a result, detailed facade studies were made to analyze the proportions of facade elements relative to the whole. Classically inspired proportion in

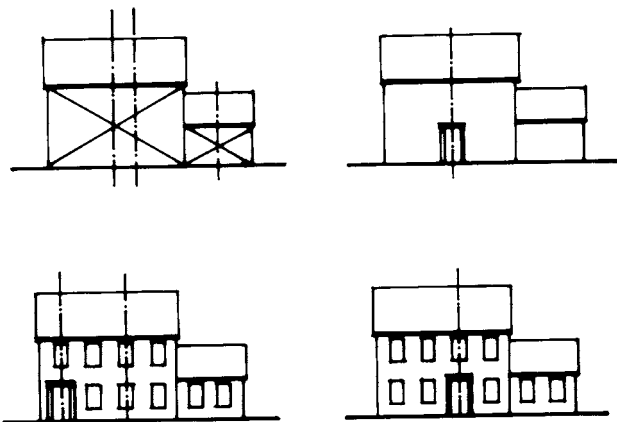

Figure 47. Balance in facade design. The first level of analysis of a building facade is its balance. Doors, windows, and other elements of a building have visual weight that balances around a visual axis.

American architecture was introduced to the colonies principally by means of English pattern books and carpenters' guides. Using such printed information, craftsmen in eighteenth-century America were able to provide even modest dwellings with exterior moldings and trim originally designed for grander houses. The visual harmony that is so noticeable in Annapolis was the result of the skill of the local craftsman and the availability of published guides.

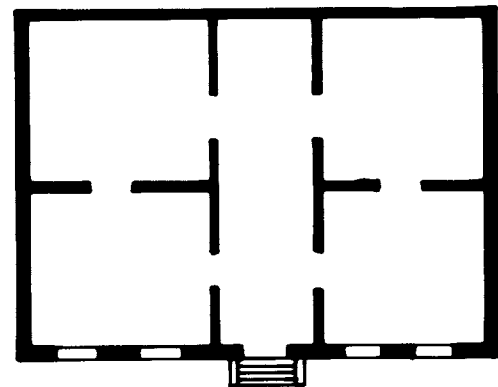
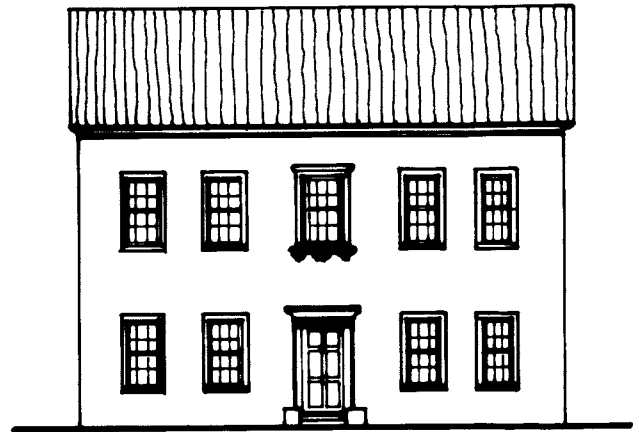

Figure 48. Front elevation and plan of a center hall plan house. The symmetrical facade is a highly ordered facade. The center doorway with two windows on either side implies an ordered plan consisting of center hallway and flanking rooms.

In Annapolis, the proportions of windows and doors relate quite directly to the proportions of building elevations. The vertical proportions of a tall row house are reinforced and repeated in the vertical emphasis of its windows, doors, and even the door paneling. The horizontal proportions of the great houses are repeated in the planar areas of brick between windows, and floor plans.

Order

Order in architecture refers to the arrangement and relationships of the parts of a building. The first level of analysis of a building facade is its balance. Doors, windows, and other elements of a building's design may be said to have visual weight that balances around a visual axis. A symmetrical facade, in which a center doorway is flanked by an equal number of evenly spaced windows on each side, is a highly ordered facade. A symmetrical facade suggests to the viewer that an equally ordered plan consisting of center hall and flanking rooms exists inside. A symmetrical facade is more formal than an asymmetrical one, and may be used to convey the stature or significance of a more important community function (such as a church or courthouse) or a higher social status (such as a great house). An asymmetrical facade is generally less formal and less pretentious. Although the side-hall row houses of Annapolis have asymmetrical facades, they are, nonetheless, ordered. This order derives from the relationship of the

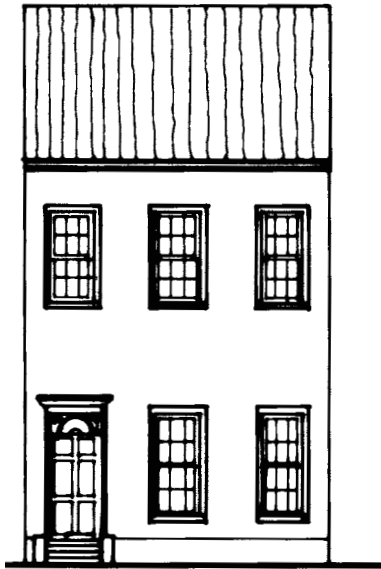

Figure 49. Front elevation and plan of side hall row house. Although the side hall plan house has an asymmetrical facade, it is ordered. This order derives from the relationship of the exterior arrangement of door and windows to the interior floor plan.

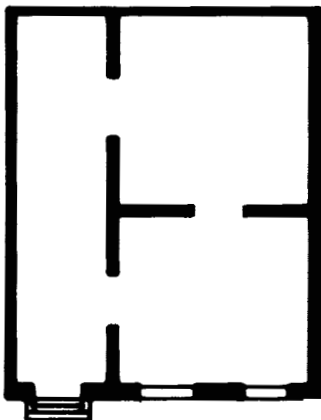

Figure 50. 86-88 State Circle, 1878. This pair of semi-detached dwellings skillfully employs the Queen Anne Revival use of projecting bays, paneled brick chimneys, specialized window shapes, and picturesque composition. (Marion Warren Collection, Maryland State Archives, MSA SC 1890-2897)

exterior door and window arrangement to the interior floor plan.

Each architectural style typically has embraced a system of scale, proportion, and order determined by the theoretical basis of the style. In the late-nineteenth century "Revival" styles, a deliberate effort was made to break away from the rules or principles governing classically inspired architecture. The Revival styles emphasized the romantic, avoided symmetry, and emphasized changes in scale and proportion to create picturesque compositions.

Rhythm

Rhythm in architecture refers to the spacing and repetition of building elements. Almost all buildings are made of elements that repeat themselves, for example windows on a building facade or courses of brick. Row houses along a street create a rhythm by repeating a



Figure 51. Houses along Market Street. The regular spacing of houses creates a rhythm along the street.

similar width, due to the length of traditional floor joists. Detached dwellings in Annapolis create a pattern of solid and void along some streets. Building components, such as porches and stoops, also create a pleasing rhythm along streets.

The rhythm of a building facade is created by the pattern of alternating wall and window areas, reinforced by the pattern created by multi-pane sash windows. Windows in historic building facades usually are not uniformly spaced, creating subtle complexities which express the order of the building plan.

Because the modern office building does not require natural light for interior working spaces, it is characterized by undifferentiated space and a resulting standardized window pattern. The monotony created by this lack of historic rhythms is one of the most frequent criticisms made of modern architecture, and is particularly destructive to the character of a historic district.

Figure 52. Calvert House, 58 State Circle, altered late nineteenth century. Paired windows separated by planar areas of brick work create a visually dynamic rhythm.

Note the centering of dormers over each pair of windows. (Marion Warren Collection, Maryland State Archives, MSA SC 1890-3680)

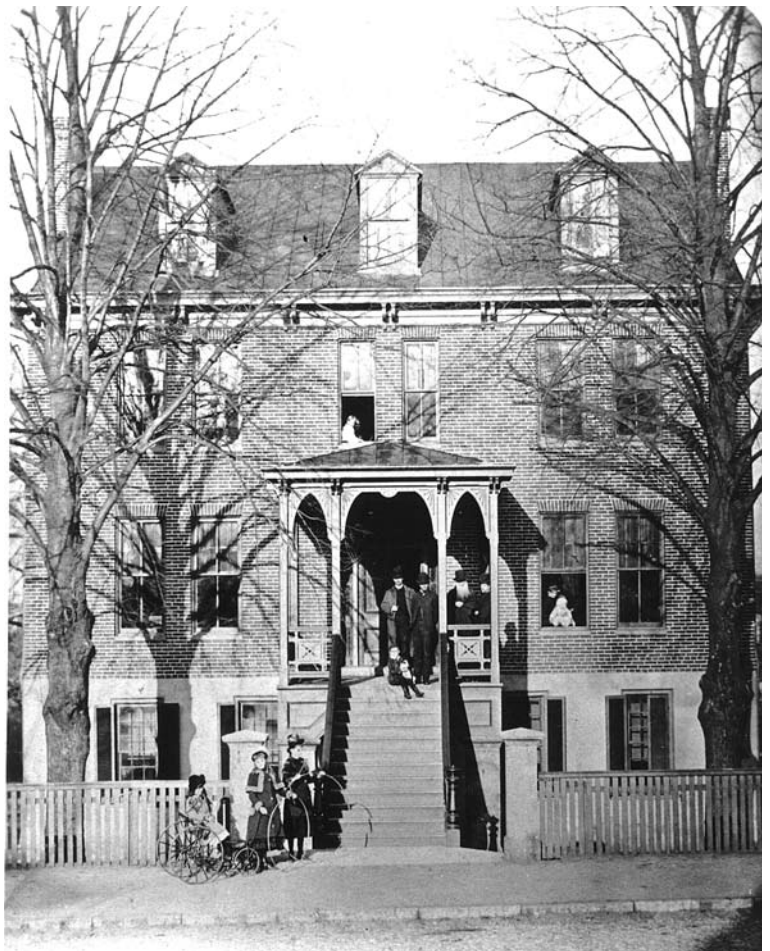



Figure 53. Houses along Pinkney Street (left and below). The syncopated rhythm of porch posts and breaks in the porch railings relate directly to the entrance doors of these row houses. The rhythm of stoops along Pinkney Street expresses and identifies individual dwellings along the row. (Photographs courtesy of Donna C. Hole)



Figure 54. North elevation of 99 Main Street, 1790. The pattern of windows and wall on a facade creates a rhythm along the street. The change in window width and resulting change in rhythm from the first floor to the upper floors increases the visual interest of the facade. (Drawing courtesy of Historic Annapolis Foundation)

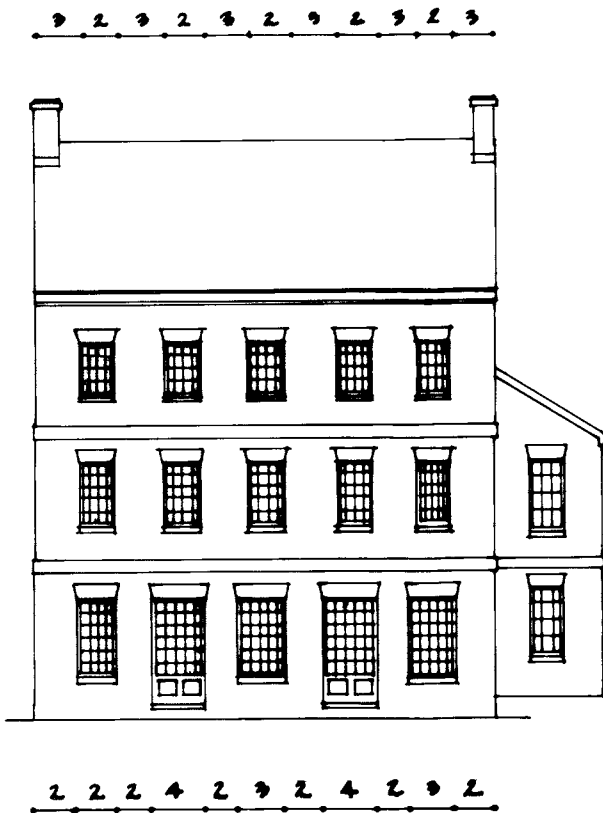



Figure 55. The Zimmerman House, 138 Conduit Street, c. 1895. (Marion Warren Collection, Maryland State Archives, MSA SC 1890-2990)

Historic District Design Guidelines

CONTRIBUTING TO A CONTEXT OF ARCHITECTURAL UNITY

The purpose of the Annapolis historic district ordinance and these design guidelines is to protect the character of historic streetscapes and buildings within the historic district. This protection is achieved in two ways: 1) By encouraging new design which is visually compatible with a historic setting, and 2) By promoting alterations which are sensitive to historic buildings and streetscapes.

The historic district possesses a strong urban character formed by its radial city plan, sloping terrain, and views to the water. Within this unique framework survives an outstanding collection of eighteenth century Georgian houses amidst a setting of nineteenth and twentieth century buildings of diverse styles. For all its diversity, there is a visual unity within the historic district which results from the human scale of the district's buildings and streetscapes. It is this unity which the ordinance seeks to preserve.

These guidelines provide the criteria required for applicants to design and to make changes which contribute to the district. Although the design guidelines are presented as a list of discrete items, the Commission's review of any application for a proposed change is not a fragmented visual evaluation. Instead, the Commission considers the overall unity and relatedness of the design to its setting. Relatedness in this sense refers to a similarity of architectural aspects to create a unified harmony of its parts to the whole. This relationship of parts to the whole applies on two levels: 1) the building as a part of the whole streetscape, and 2) the parts of a building relative to the overall building.

Organization of Design Guidelines

Guidelines are organized following the five broad preservation goals of the Historic Preservation Commission, as follows:

- A** Guidelines to preserve and enhance the city's historic urban form.
- B** Guidelines to preserve and enhance individual historic streetscapes.
- C** Guidelines to facilitate compatible landscape and site design.
- D** Guidelines to preserve and protect historic buildings, materials, and elements.
- E** Guidelines for archaeology



Figure 56. Aerial view of Annapolis. The radiating streets of the original town plan opened on to the water or an orthogonal street at one end, and were closed by State Circle or Church Circle at the other. (Photograph courtesy of Kevin Fleming)

GUIDELINES TO PRESERVE AND ENHANCE THE CITY'S HISTORIC URBAN FORM

A.1 - The Town Plan and Focal Points

New buildings should reinforce the historic town plan of Annapolis and should respect traditional views and visual focal points including the State House, St. Anne's Church, and the water.

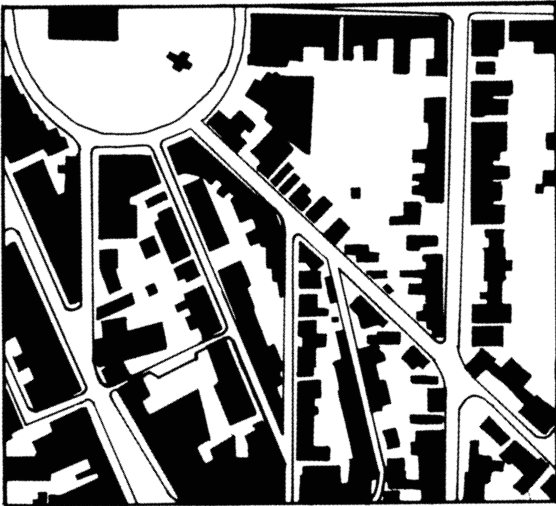

Figure 57. Partial plan of the historic district street intersections. Triangular and other unusual-shaped lots were created by the intersection of radiating streets with other streets. At all street intersections, corner buildings should follow the property lot lines in order to reinforce the town plan.



Figure 58. View of Spa Creek waterfront. Exterior changes to properties visible from Spa Creek and the harbor, both historic "public ways" in Annapolis, are subject to the requirements of the Historic District Ordinance. (Photograph courtesy of Donna C. Hole)

the scale of the street and disrupt the constant visual width of the street space.

A. 2 - Reinforcement of the Unique Town Plan

New development on corner lots should preserve and reinforce the unique geometry and spatial relationships formed by these intersections.

The unusual triangular shaped lots at radiating

street intersections are expressed in the floor plans of historic corner buildings such as the Maryland Inn, and should be expressed in new buildings. Corner buildings at right angle corners should follow the street form, and should relate visually to both streets.

Figure 58. View of the Maryland Inn, viewed from Church Circle. The triangular plan of the building end strengthens the urban form of radiating streets. (Tracerics, 1994)



A. 3 - Views from the Water

All projects which are visible from the water shall respect and reinforce the historic

character of the district and shall respect traditional views and visual focal points.

The dramatic pattern of streets converging on major spaces and radiating outward to views of the water (or other streets leading to the water) can be affected adversely by site planning and building design which do not reinforce the pattern. For example, large buildings at the visual terminus of a street may alter the human scale of the street and block historic views beyond. Changes in building setbacks also may alter

The earliest settlements in the city were along Spa Creek and the Severn River. Visitors to Annapolis often came by water, making the system of rivers and creeks an important gateway to the district. View sheds of the water as well as historic streetscapes as seen from the water have a shape and proportion that have evolved

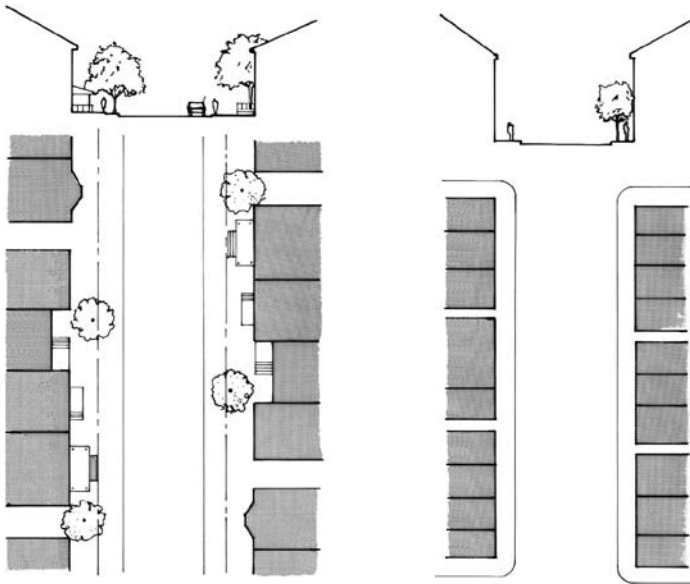
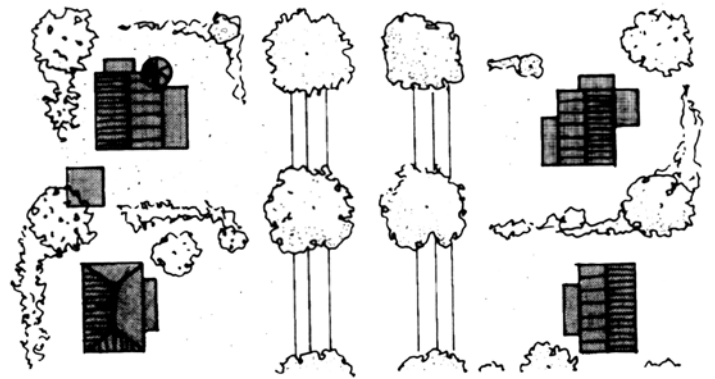

Figure 60. Plans and sections of “representative” streetscapes in Annapolis. There is no “typical” streetscape in Annapolis. The size of buildings, width of street, setbacks, and building use vary from neighborhood to neighborhood. Figure A (far left) shows a section of the most compact residential development in the historic district, for example, Fleet Street. Figure B (left) shows a section of a commercial block, for example, Main Street; and Figure C (below) shows a more suburban pattern of houses with front yards and landscaping, for example, Southgate Avenue.



in response to the growth patterns of Annapolis. The scale, placement and configuration of new structures, and plantings within these view sheds need to be carefully planned so that new elements do not alter or obscure the character of these historic patterns. Beyond the larger scale elements, an effort should be made to eliminate smaller objects that are likely to produce a sense of visual clutter. Visual clutter competes with and obscures the historic sense of space that is so essential to understanding the urban planning of Annapolis and its historic connection to the water.

The City Code provides for the establishment of a view cone wherever a public right-of-way terminates at a waterway (Section 21.60.080). **Fences, walls or plantings within the view cone cannot exceed 6 feet in height and must be transparent above forty-eight inches (48”).** Trees shall not be planted closer than 15 feet apart so as not to form a visual barrier. All plantings other than trees must be maintained at a height of forty-eight inches (48”) or less. The height of a fence, wall or planting shall be measured from the grade of the public right-of-way. In the case where there is a change of grade, at no point along the barrier shall the height exceed the limits stated above except in such case were there are documented historic records to the contrary. The handrails and guardrails around open terraces and open porches within a view cone shall be transparent.

GUIDELINES TO PRESERVE AND ENHANCE INDIVIDUAL HISTORIC STREETSCAPES

Introduction

The residential streetscape is an ensemble of street, sidewalks, fences, vegetation, and buildings. Each part is

a layer in the transition from public to private space, and each is subject to the review of the Historic Preservation Commission. Public space includes the street paving for vehicles and sidewalks for pedestrians. Front yards, stoops, and porches, while privately owned, are visually semi-public. Rear yards and side yards separated from the street by fences or hedges are private spaces. A well-maintained walk, plantings, and a preserved building are public gestures representing the efforts of generations of residents to create a public presence in the city, which transcends personal gain.

Buildings and landscape elements form walls of outdoor spaces, which become the public halls and reception rooms of the city. Street and sidewalk paving is the flooring of these rooms, and the vegetation and street furniture the furnishings. The historic district ordinance is in place to protect the streetscape from insensitive change. The ordinance discourages the removal of landscape elements and obliteration of the streetscape “walls” by a change in setback, any increase in the height and width of the “walls,” removal of the historic human scale, or disruption of the existing order and pattern of rhythm along the street.

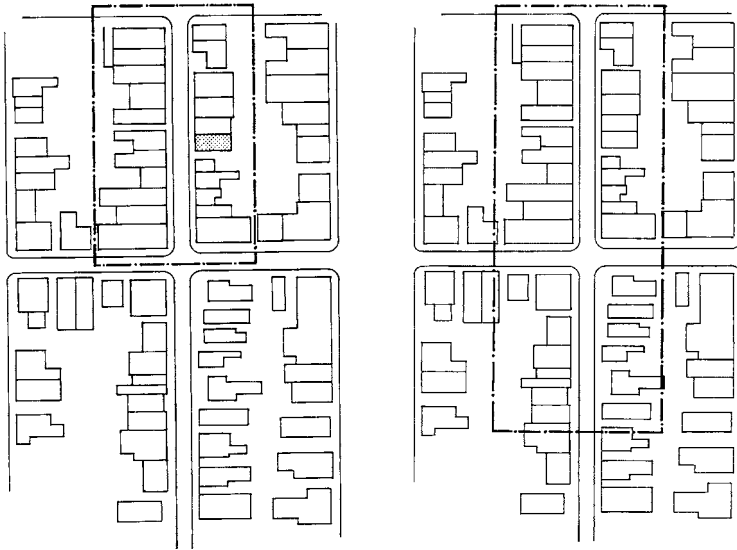

Immediate neighborhood of a lot at the center of a block.

Immediate neighborhood of a corner or near-corner lot.

Figure 61. A new building should relate to the predominant historic characteristics of its immediate neighborhood.

GUIDELINES FOR BUILDING DESIGN

B.1 - Visual Relationships between the Old and New

A new building or addition should visually relate to contributing historic buildings in its immediate neighborhood rather than to buildings in the historic district in general. The "immediate neighborhood" is generally defined as at least 1/2 block in both directions.

The Historic Preservation Commission will consider the appropriateness of a proposed design for its specific

location. Designs or changes approved elsewhere in the district do not act as a precedent for a design under consideration. The immediate neighborhood of a proposed alteration, addition, or new building includes the subject lot and all lots on both sides of the street on which the lot fronts and the interior of the affected blocks for projects impacting the rear of the subject lot. For a corner lot or a lot adjacent to a corner lot, the immediate neighborhood includes all sides of the intersection. Where a lot falls near the edge of the historic district, historic buildings located near but outside the district boundaries are included in the lot's immediate neighborhood.

B. 2 - New Building Design

The design of new buildings and additions should be compatible with, but not imitate,

DISTRICT	HEIGHT OF CORNICE AT SETBACK LINE	MAXIMUM ROOF HEIGHT
District 1	22'-0"	32'-0"
District 2	28'-0"	38'-0"
District 3	35'-0"	45'-0"

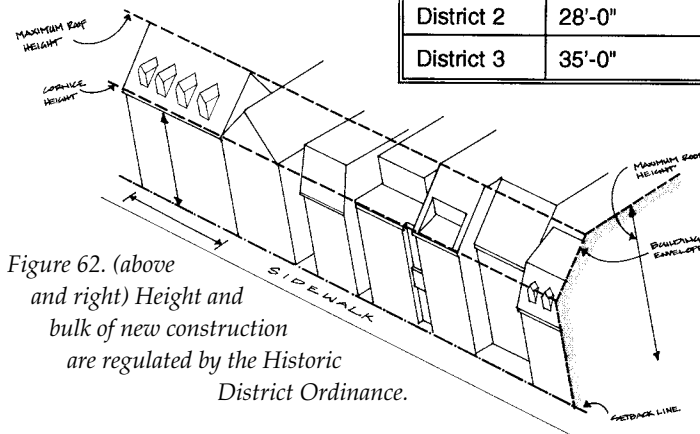

Figure 62. (above and right) Height and bulk of new construction are regulated by the Historic District Ordinance.

existing historic buildings.

New buildings which merely imitate the forms and materials of historic buildings dilute the quality of existing historic structures. Just as

a museum would not present copies of art alongside original works of art, constructing copies of historic buildings among genuine ones is discouraged. Creative building design which is compatible with the character of the immediate neighborhood is encouraged.

New buildings should be designed to strengthen the unity of the existing streetscape, and should follow the design principles of historic architecture described earlier. New buildings should not be mistaken for historic buildings.



Figure 63. Anne Arundel County Courthouse, Church Circle. Despite its large size, the courthouse facade facing Church Circle has a human scale because of the skillfull changes in plane and additive massing.

B. 3 - Building Height and Bulk

New buildings should respect the bulk and height of neighboring buildings. The facade height and proportions of new buildings should be compatible with the predominant character of other buildings in the streetscape.

Building height maximums and bulk regulations are contained in the Annapolis City Code (Sec. 21.56.Art.II). To determine in which height district your property is located, please contact the Department of Planning and Zoning. The City Code reflects the maximum allowable height; however, the HPC may require a lower height based on the specific site and proposed building.

Limiting the bulk and height of new construction is essential to protect the human scale of Annapolis streetscapes. When viewed from the street, the facade of a structure is its primary visual presence. The facade's width and its sidewalk-to-cornice height are the predominant dimensions seen from the street and give the building scale and proportion. If the facade is not a single plane, the dimensions of each plane facing the street usually establish the facade's scale. A skillful historic example of a large building "broken down" to a human scale by means of changes in planes is the Anne Arundel County Courthouse located on Church Circle. Built in 1824 and expanded in 1892, it was enlarged substantially in 1999 during a careful design review process involving the HPC.

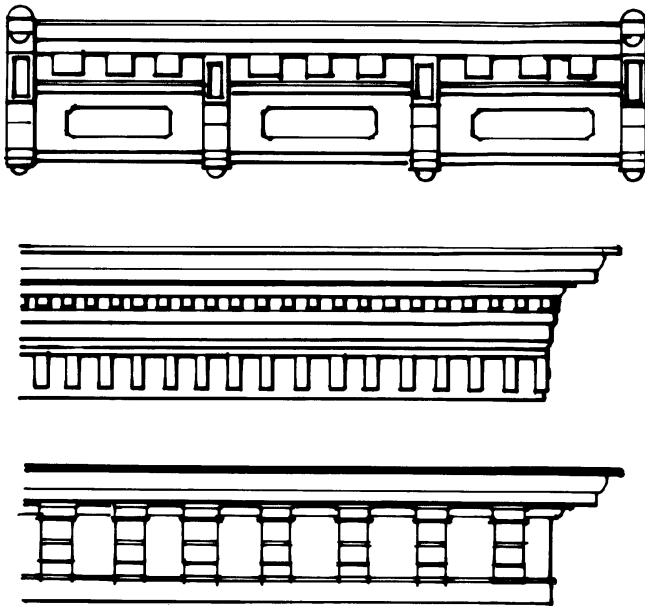

Figure 65. Details of Annapolis cornices. In new buildings and additions, the facade should be capped by a cornice relating to the scale of the proposed facade.



Figure 64 Example of inappropriate infill. The building on the left is not integrated with the buildings that surround it. (Photograph courtesy of Donna C. Hole)

B. 4 - Relationship of Facade Parts to the Whole

All parts of a new building facade should be visually integrated as a composition which should relate to adjacent buildings.

The size and proportions of facade elements such as doors, windows, cornices, and water tables emphasize the vertical and horizontal dimensions of a facade. Exaggeration of these elements and the use of ribbon windows, vertical stacks of windows, and contrasting color brick courses create a design that is not compatible and out of proportion with historic buildings. The building cornice is a classically derived design feature, which caps the facade wall and finishes off the roof form. The scale and ornamentation of the cornice are proportioned to the dimensions of the facade and style of architecture. The facade of a new building or addition should be capped by a cornice relating to the scale and articulation of the proposed facade and other buildings in the immediate neighborhood.

B. 5 - Scale and Massing of Large Buildings

Large new buildings should be designed as a series of masses or building elements compatible with the immediate neighborhood.

"Building elements," as referenced in Height and Bulk Limits, Chapter 21.56, Art.11 of the City Code, are the traditional size "building blocks" or masses most prevalent in the neighborhood of the proposed new building. The massing or volumetric shape of a building greatly affects the scale of a building and underlies all other architectural features.

The typical Annapolis building is a simple volume, usually two stories in height, topped with a sloped roof. Large traditional buildings consist of assemblies

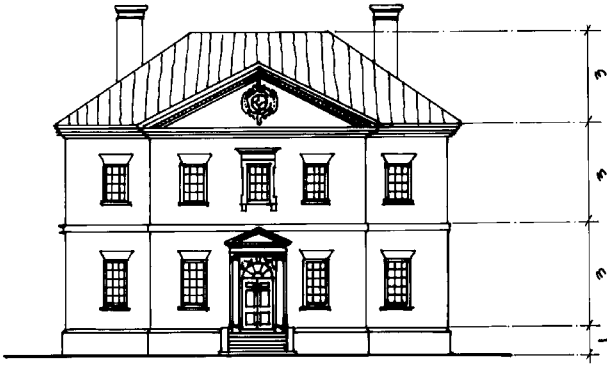

Figure 66. Front facade of the central block of the Hammond-Harwood House. The water table, belt course, and cornice (entablature) divide the facade of the building into nearly equal parts.

of building blocks. This method of assembling building blocks is described as additive massing. It was traditionally employed in enlarging and adding to existing buildings, as well as in planning new structures. A sense of order is always maintained by keeping one mass visually dominant. The five-part Palladian plan, with its symmetry of smaller parts flanking a large central mass is the epitome of formal additive planning in Annapolis.

B. 6 - Size and Massing of Additions

Additions shall be designed to be subordinate to the main part of the building in terms of massing,



YES A successful example of a large building broken down into two "building elements." (Sketches courtesy of Vivian P. Hopkins)



NO The large mass and size of this new building are not compatible with its immediate neighborhood.

Figure 67. A proposed building which exceeds the size of adjacent buildings should be planned as an additive composition made up of traditionally sized "building blocks" or "building elements."

Figure 68. Traditional additions to an attached and a detached residence. The visual prominence of the original building is maintained.

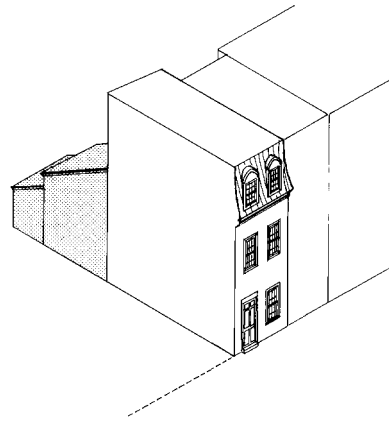
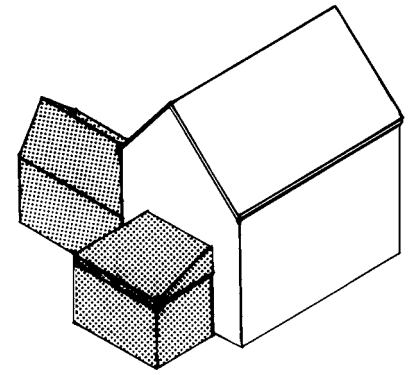

height, scale and detail. **Additions which compete with or obliterate an original structure will not be approved.**

The historic building should retain its original massing and visual characteristics. Additions

that compete in size with original buildings are strongly discouraged. If the addition is large relative to the existing building, it should be designed with setbacks,

offsets, hyphens, change of materials, or mediating architectural details relating to the original structure. The addition of projecting bays, oriel windows, or other incompatible additions should be avoided.

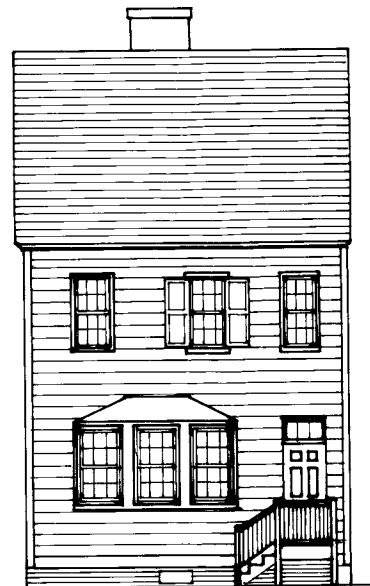

Figure 69. The projecting oriel window which combined two historic windows disrupts the proportions and rhythm of the facade.

B. 7 - Cornice Heights

The eave height or cornice elevation of new buildings should relate to the cornice or eave height of adjacent buildings.

Where all buildings in

a row of three or more buildings are at the same height, the cornice height of a new building should horizontally align with the contiguous cornices of the other structure.

B. 8 - Roof Shapes

Roof shapes on new buildings or additions should visually relate to the roof forms and slopes on neighboring historic buildings.

The predominant roof form in the historic district is the gable roof. The most common roof forms on additions were gable and shed. On many row houses and commercial buildings, a shallow-pitched shed roof was completely concealed behind a decorative parapet or a false mansard roof. **Modern, simplified forms of the Mansard roof shall not be permitted.**

The pitch (slope) of a roof is related to the roof type. Gable roofs should not have less than a 7-in-12 pitch (7 inches of roof rise over a horizontal distance of 12 inches). Steeper roof pitches should be governed by the individual context. Shed roofs with sheet metal roofing may have a low pitch. Gambrel roof slopes should be based on a historic precedent.

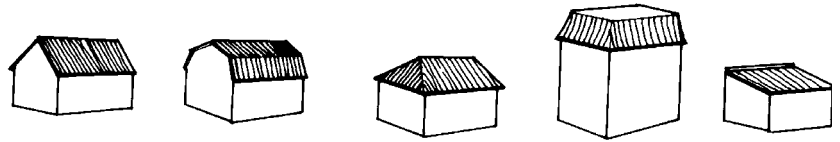

Figure 70. Prevalent roof form types in the Annapolis historic district.

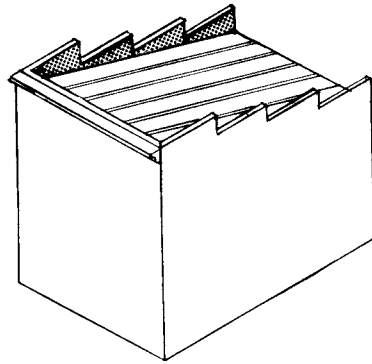

Figure 71. A shed or flat roof is often concealed by a raised parapet on commercial buildings.

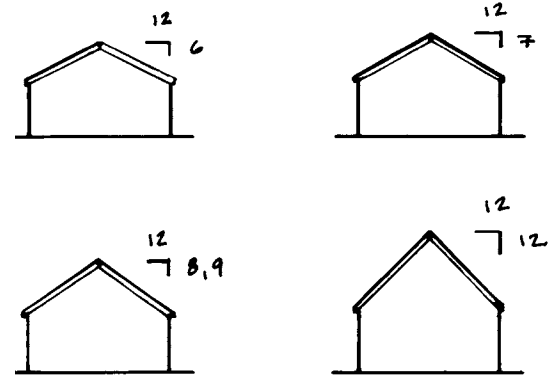

Figure 72. For gable roofs, the roof slope of additions and new buildings should not have less than a 7-in-12 pitch, and not more than a

10-in-12 pitch except where a proposed addition roof is matching a steeper slope on an existing building.



Figure 73. Historical photographs such as this view of Middleton Tavern, 2 Market Space, provide invaluable information regarding the earlier appearance of historic buildings. (Courtesy of Historic American Buildings Survey, Library of Congress. E. Pickering, 1936)

B. 9 - Reconstruction of Building Components

Replacement of missing building elements and proposed reconstruction of building components shall be based on surviving physical evidence and historic photographs.

Where traces or fragments of removed building elements survive, they should be recorded and preserved for use in reconstructing the missing element.

Wherever possible, the reconstruction of missing building elements should be based on remaining physical evidence of the original element. Where inadequate physical traces survive, reconstructed elements should be determined by enlargements of historic views.

GUIDELINES FOR SITE DESIGN

B.10 - Prevailing Setbacks

The prevailing setback line at the street should be preserved. The pattern of setbacks surrounding a specific site may be considered as well.

Any new construction should address the street in a manner consistent with neighboring structures and the overall street form and character. The facade of a planned new building should respect the alignment of existing building facades relative to the sidewalk edge. On blocks where buildings are set back, a new building should conform to the prevailing setback line.

The presence of front and side yards varies from street to street in Annapolis. For any proposed addition or new building, the immediate neighborhood of the subject property will be considered in establishing an appropriate setback for the proposed construction.

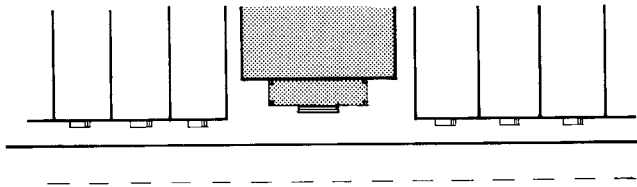

NO The new building (shaded) is not compatible because it is wider than existing buildings on the street and because the front facade is set back from the front lot line.

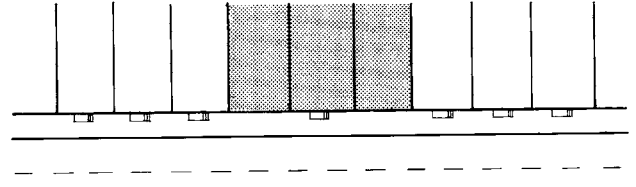

YES The new building (shaded) blends into the existing streetscape by being broken down into **building elements** and by repeating the prevailing setback.

Figure 74. Plot plans along a street showing successful and unsuccessful new building.

B.11 - Building Widths and Spacing

The prevailing relationships of building widths and the spaces between buildings should be respected and preserved.

Where buildings are built out to the side lot lines, new buildings should be built out to side lot lines to maintain the sense of a “wall” along the street. Where buildings are clearly separated from one another by side yards, new buildings and additions to existing buildings should not encroach into the side yard spaces. Where the spacing of buildings and side yards creates a rhythm, new buildings and additions to existing buildings should not alter that rhythm.

B.12 - Stoops and Porches

New construction should incorporate traditional elements which give scale to the streetscape, such as porches or stoops, when they are present on adjacent historic buildings.

Stoops and porches make two important contributions to the streetscapes of Annapolis: 1) they provide a sense of human scale for a tall masonry wall, and 2) they create a rhythm along the street. See also guideline D.23.

B.13 - New Garages and Driveways

Garages and surface parking areas shall be concealed from the street by their location or by screening with architectural or landscape features.

Garages, driveways, and surface parking areas are twentieth century introductions to the historic district. For new garage or driveway construction to be considered, plans must be in scale with the proportions of the site and consistent with the architectural era of the existing structures. When the HPC determines that a new garage is appropriate *based on the early 20th century character of the neighborhood and house*, the structure should be placed at the rear of the lot, detached from the main house. The scale and detailing of the primary façade of the garage should be similar to the historic residence, and to other outbuildings in the district.

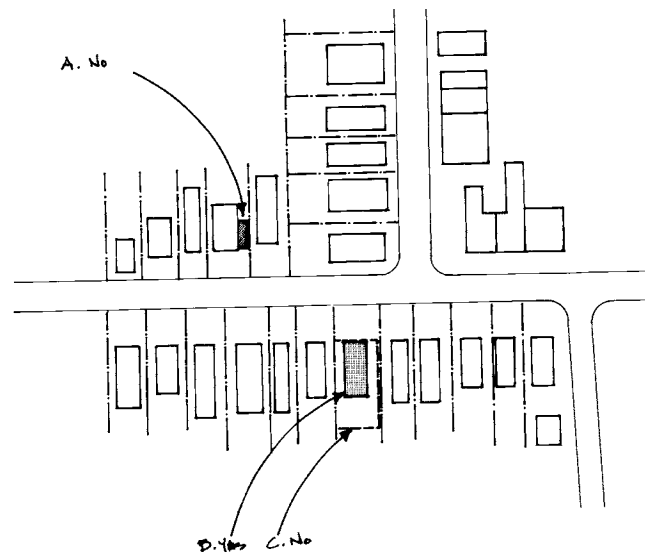

Figure 75. A new building or addition in a neighborhood of regularly spaced houses should follow the existing pattern. Addition “A” encroaches on its side yard, interrupting the spacing between houses. New building “B” conforms to its immediate neighborhood. Building “C” is built the full width of its lot, disrupting the rhythm of spaces and buildings.

GUIDELINES TO FACILITATE COMPATIBLE LANDSCAPE AND SITE DESIGN

C.1 - Landscape Design and Materials

Landscape design and materials should be appropriate for both the streetscape and the building to which they directly relate. The Commission shall be stricter in its criteria for landscaping fronting the public way than for the areas typically considered private landscape areas.

Landscape design, materials, and plant preferences have changed over time. Within the historic district, landscaping visible from a public way should be traditional in character, relating to both the building on the site and the streetscape in general.

C. 2 - Topographical Features

Historic topographic features should be preserved wherever possible.



Figure 76a. Stoops at Calvert and Clay Streets (demolished). Stoops provide a sense of human scale and they create a rhythm along the street. (The Annapolis I Remember Collection, Maryland State Archives, MSA SC 2140-437)

To comply with the *Secretary of the Interior's Standards*, the relationship of a structure to its site should not be altered except in instances of the restoration of a historic landscape. Documented features may be restored. Leveling or terracing a lot that was traditionally characterized by a natural hillside is not recommended. All grading for sites over 5,000 square feet requires a permit from the Department of Public Works.

C. 3 - Building Access for the Mobility Impaired

Building accessibility for individuals with disabilities should be achieved without compromise to historic materials or to character-defining elements of historic buildings and sites.

Every effort should be made to avoid ramps and handicap lifts on primary facades of buildings. Methods of achieving accessibility should be integrated into the site plan.

C. 4 - Tree Removal

Mature trees and shrubs should be preserved whenever possible.

Trees cannot be removed without a permit from the Department of Neighborhood and Environmental Programs and the HPC. The historic district is located within the state's Chesapeake Bay Critical Area and any tree that is removed has to be replaced according to a formula based on the size and species of the tree. Replacement may occur either on site or off site.

C. 5 - Retaining Walls

Retaining walls shall be built with traditional masonry materials and methods. **Railroad ties, pressure treated lumber, simulated stone and wood are not appropriate for use as retaining walls or as decking.**

C. 6 - Fences and Other Landscape Features

Fence designs and site walls for existing buildings should relate to the architectural style of the building. Fence designs and site walls for new buildings should relate to both the new building and to the predominant style of fencing of neighboring buildings. Arbors, pagodas and other landscape features are subject to HPC review and must be consistent with the overall style of the building. **The following fence types are not compatible with historic district landscapes and are not permitted: chain link, vinyl, trek, shadow box/board on board, and stockade. Latticework is an inappropriate component of fence design.**

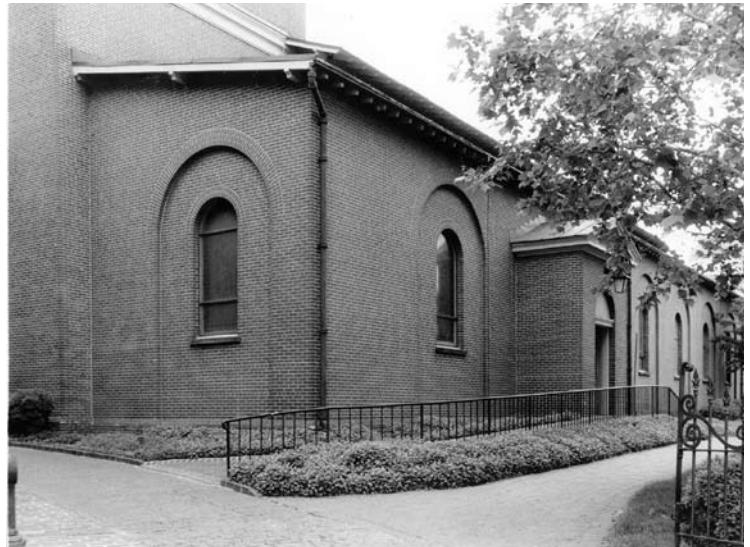

Figure 76b. View of unobtrusive handicapped access ramp, St. Anne's Church.

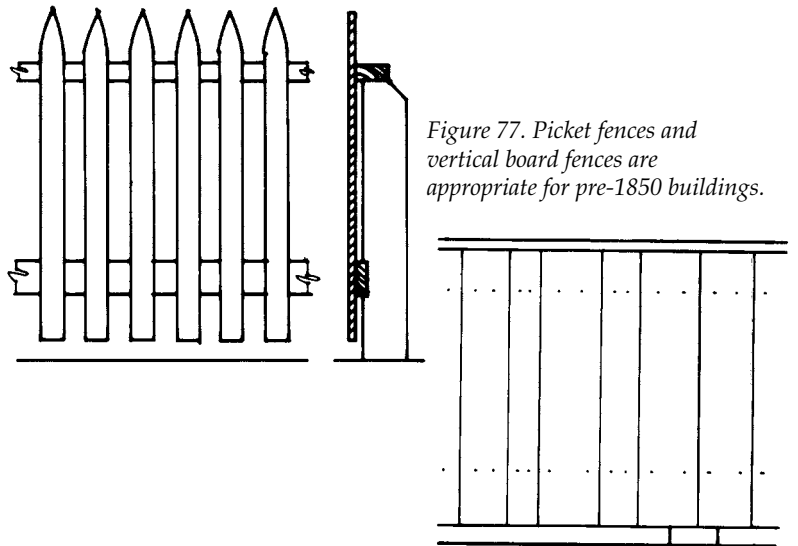

Figure 77. Picket fences and vertical board fences are appropriate for pre-1850 buildings.

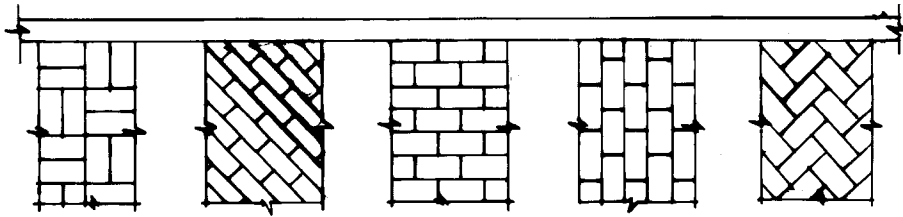

Figure 78: Brick paving patterns which are pre-approved by the Historic Preservation Commission. Left to right: Basket Weave, Diagonal Flat, Cross Flat, Running Flat, Herring Bone.

Fences are evaluated in three different categories: front, side and rear locations. Front fences should be low and visually transparent. Side fences should not extend beyond the front plane of the structure and may be higher than the front fence but not substantially alter the historic sense of open spaces between structures. Rear fences should not extend forward of the rear plane of the structure and typically should define the private areas of the landscape.

Fences for pre-1850 buildings should be wood picket or vertical board construction. While Victorian style residences frequently employed elaborate ornamental fence designs, elaborate conjectural designs are discouraged unless clear photographic evidence survives for the proposed design on the affected site.

C. 7 - Landscape Lighting

Landscape lighting should provide a clear view of any potential obstacles in the environment, such as stairs and pathway intersections, and ensure personal safety. Lighting may be installed to deter trespassers, to enhance security and to illuminate property addresses adequately.

Up-lighting, either on plantings or structures, is not permitted except for public, semi-public or landmark buildings.

C. 8 - Landscape Planters

Landscape planters should be made of red clay or tinted pre-cast concrete and should relate in size, scale and detail to their site.

Plastic, white concrete and wooden barrel planters are not appropriate.

C. 9 - Landscape Plants

Landscape plants should be carefully chosen to relate in size and scale to the building and spaces around the planting area on the site. Landscape plants that are appropriate for the period of the building are encouraged. Plants used for a new building should be compatible with neighboring historic buildings and sites. Use of plant material to screen utility structure is encouraged.

Historical landscape architects and horticultural

specialists should be consulted for significant landscapes. Planting styles and designs should approximate the period of the building. Parterres would be appropriate to 18th century buildings, while foundation plantings would be a 19th century style.

The ultimate size and massing of the plants must be taken into account, as well as possible adverse effects on historic building materials. The use of native species is encouraged to reduce fertilizer and pesticide use and improve compatibility with local climate conditions. Lists of native plants and historically appropriate plant materials are available from Department of Planning and Zoning staff.

C.10 - Curb Cuts and Off Street Parking

Curb cuts and off street parking areas are discouraged. Where appropriate, they shall be carefully planned to protect the historical character of the property and adjacent properties. Paving materials should be historic, preferably brick.

In addition to the visual appropriateness of a proposed curb cut or parking area, the Commission will also consider such physical factors as whether the cut will require altering the topography of the site and how the proposed drive will affect existing vegetation.

Asphalt and gray Portland cement concrete paving are discouraged, as are gray gravel and white stone. Preferred materials include crushed oyster shell, brick, and brick tire tracks.

C.11 - Sidewalk Paving Materials

Sidewalk paving should be brick, or match the paving material on contiguous property. Brick should be laid in one of five traditional patterns. Paving materials for garden walks should be traditional. Brick and crushed oyster shells are appropriate.

C.12 - Street Furniture

Street furniture such as benches, bus shelters, trash receptacles, bollards, news racks, bicycle racks and tables should be simple in character, constructed of wood and painted metal. They should be compatible with the style and scale of adjacent buildings and outdoor spaces. In the approval process, consideration

will be given to number and placement as well as resultant clutter. Consideration may also be given to the interplay between the rhythm created by the street furniture and the architectural rhythm of the nearby streetscape. (See page 70 for more detailed information on Sidewalk Café Furniture.)

GUIDELINES TO PRESERVE AND PROTECT HISTORIC STRUCTURES AND THEIR COMPONENTS

D. 1 - Secretary of the Interior's Standards for Rehabilitation

Except where more stringent requirements are stated in these guidelines, all work done on historic buildings should comply with the *Secretary of the Interior's Standards for Rehabilitation*.

D. 2 - Demolition

Demolition potentially alters the essential character and integrity of the historic district and shall be reviewed strictly. The demolition of contributing resources (including but not limited to buildings, outbuildings, individual features and landscapes) does not meet the *Secretary of the Interior's Standards* and should not be approved. **When hazardous public safety conditions are determined to result from neglect on the part of the property owner, the property is subject instead to the provisions of Section 21.56.090 - Maintenance, Repair and Demolition by Neglect in the Historic District.**

A demolition may be approved by the Commission if one of the following two conditions exists:

1. The Department of Public Works orders demolition because of an existing dangerous condition that constitutes an emergency hazard to public safety.
2. The requested demolition will remove an inappropriate addition or incompatible building, and such removal is determined to have no adverse impact on the streetscape and/or overall integrity of the district.

In its deliberations the Commission may consider the following:

1. The significance of the resource affected
 - a. contributing versus non-contributing
 - b. primary versus secondary component (garage, shed etc.)
 - c. age of resource
 - d. within or outside the period of significance of the district;
2. Whether the resource is the only or one of the last

3. Whether the resource is a good example of design, materials or workmanship;
4. Evidence that rehabilitation/restoration is neither technically nor economically feasible due to the design, materials, location or other factors;
5. Imminent collapse of structure and inability to stabilize;
6. Feasibility of alternatives to demolition.

In accordance with City Code Section 21.56.090, no demolitions except those undertaken for public safety shall be approved until plans for a replacement structure have been submitted to and approved by the HPC.

Archeological research shall be conducted prior to demolition.

D. 3 - Preservation of Significant Original Features

Distinguishing original and historic features of historic buildings and their sites shall be preserved.

These features include distinctive stylistic features, examples of skilled craftsmanship, and features such as original siding, roofing material, windows, and doors.

The restoration of historic building materials should be completed by craftsmen with specialized skills in building restoration.

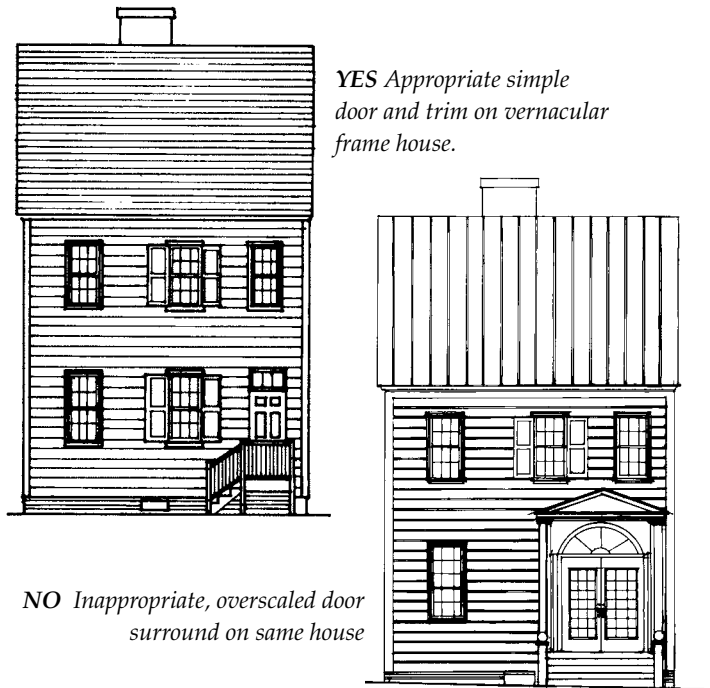

Figure 79. Detail of William Paca House foundation and cellar window. The all-header brick bond and the pebbles in the stonework mortar joints (galleting) are distinctive Annapolis details which require skilled craftsmanship to preserve.

D. 4 - Preservation of Historic Alterations

Significant changes to historic buildings and sites which have taken place over time are evidence of the history of the building. **Changes which have achieved significance shall be preserved.**

Most buildings have evolved over time as technology and uses changed. As a result, few buildings are in their original form. Although certain alterations may be inappropriate or non-contributing, most changes are important because they reflect the changing needs of building occupants over time. However, removal of intrusive, insignificant alterations will be considered on a case by case basis.



YES Appropriate simple door and trim on vernacular frame house.

NO Inappropriate, overscaled door surround on same house

Figure 80. The doorway should be scaled to the size of the facade.

D. 5 - Repair and Restoration is Preferable to Replacement

Deteriorated historic architectural features shall be repaired unless documentation of deterioration that justifies the replacement of historic material is provided. Alterations to original architectural features should be avoided during the repair process.

Patching, piecing-in, splicing, consolidating, or otherwise reinforcing or upgrading historic materials according to recognized preservation methods is preferable to replacement.

D. 6 - Missing and Deteriorated Components

Missing pieces and components of historic building features which cannot be repaired should be replaced with exact copies.

Broken, missing or deteriorated portions of architectural features should be replaced with new materials that exactly replicate the original design of the feature. Missing features should be replaced with accurate replications which are substantiated by physical

or pictorial evidence rather than by conjectural designs or designs from other buildings. Where architectural elements, such as doors, are missing, the replacement door should be appropriate to the style of architecture of the building.

D. 7 - Cleaning of Historic Buildings

Exterior cleaning of historic buildings shall be done in the gentlest way possible.

Destructive techniques such as sandblasting and the use of sealants are not permitted.

Wood siding should be cleaned using water and household detergent cleaner, scrubbing the wood work with sponges or natural fiber brushes, followed by a water rinse at garden hose pressure. Brick masonry should be cleaned using a detergent cleaner and water, or if required, using a proprietary masonry cleaner diluted in water, scrubbing with natural fiber brushes, followed by a low pressure water rinse. Cleaning methods that will damage historic building materials shall not be undertaken.

D. 8 - Exterior Colors

The HPC does not review exterior paint colors except in cases when it forms an integral part of the material proposed. It is recommended that exterior colors used on historic buildings should be based upon documentation through research or paint analysis. If paint analysis is not feasible at the time of repainting, areas where paint layers are visible should be retained for future paint analysis. Guidance on appropriate historic paint colors can be provided by HPC staff and Historic Annapolis Foundation.

Exterior colors should be appropriate to the architectural style and period of the building. For new buildings and additions, selected colors should relate to the building design and materials used, and should be compatible with other colors used along the block. Exterior color schemes for buildings should be subordinate to the composition of building elements.

If repainting of an historic building is planned, the removal of all paint layers to bare wood is not recommended. Simple scraping in preparation for new coats of paint in most cases is sufficient.

GUIDELINES FOR PRESERVING AND PROTECTING HISTORIC ROOF SYSTEMS

D. 9 - Protection of Overall Character

Historic roof systems and original roof elements, including steeples, domes, chimneys, dormers, and roof forms and materials, are important visual elements in the Annapolis historic district because

of the topography of the city. The roof-scapes of buildings at lower elevations are visually prominent from higher elevations, and waterfront roof-scapes are silhouetted from the water. Alterations that diminish or conceal these character-defining features are discouraged. Roof-top decks are highly visible and are strongly discouraged.

D. 10 - Roofing Materials - Historic Buildings

Historic roofing materials should be preserved. New or replacement materials should replicate or be compatible with the materials used on the existing structure.

Where existing historic roofing materials survive, they should be retained and repaired. If deterioration is extensive and replacement is required, new roofing should match existing historic roofing materials. For flat roofs the choice of replacement roofing materials should be dictated by technical considerations. Selection of the historic roofing material should be based on physical evidence and/or historic photographs.

New roofing should not be more rustic than the original material it is replacing. For example, sawn wood shingles are recommended for replacing existing wood shingle roofs; hand-split shakes are not. Life safety codes require that new wood shingles have fire retardant coating.



Figure 81. Detail of sawn shingle roofing, west dependency of the William Paca House.

Replacement of existing asphalt shingle roofing with new asphalt shingle roofing is not prohibited; however, replacement using the building's original roofing material (evidence for which is often found beneath the asphalt shingles) is strongly encouraged. Asphalt shingles were introduced about 1910, and thus are considered merely a less desirable substitute for wood, slate, or metal for all buildings constructed prior to 1900. Where asphalt shingle roofing is the proposed replacement material, shingles should be heavyweight, square tab strip shingles weighing not less than 290 pounds per square, of a color similar to the historic roofing material.

Unpainted, mill finished aluminum is not allowed for flashing, gutters or downspouts.

D. 10a - Roofing Materials - Additions

Roofing materials used on additions to historic buildings should be compatible with the materials used on the existing structure.

The roofing material of a proposed addition should match the roofing of the existing building. For example, where existing roofing is slate, new roofing should be slate or metal. Mixing wood or asphalt shingle roofing with existing slate is not recommended.

D. 10b - Roofing Materials - New Buildings

Roofing for proposed new buildings should relate to the overall design of the new building, and should follow the prevalent roofing material of the neighborhood. New buildings in the historic district should not be roofed with asphalt shingles.

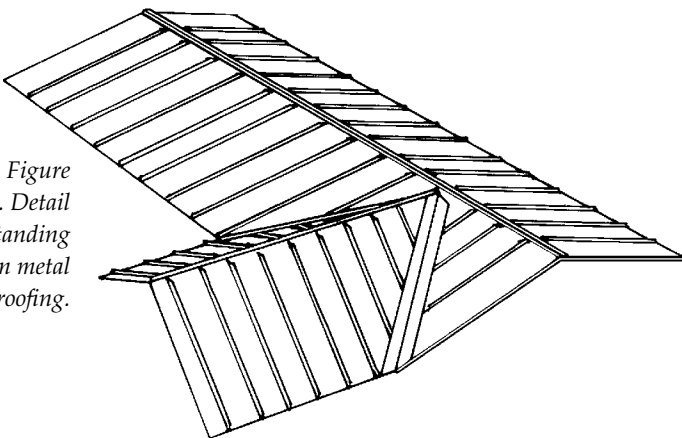
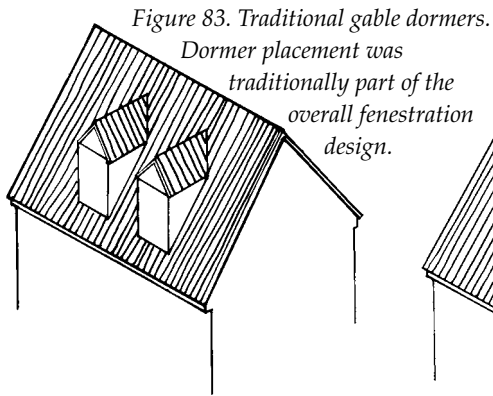

Figure 82. Detail of standing seam metal roofing.

Sheet metal roofing appeared in Annapolis after 1820 and was widely used. If metal roofing survives, it should be retained and repaired as necessary. Only severely deteriorated metal roofing should be replaced with new metal roofing, and any such substitution should be formed from rolled terneplate or copper, depending on the individual building. Pre-formed and field-painted standing seam metal roofing systems similar to historic standing seam roofing are preferable to asphalt shingle roofing.

D. 11 - Dormers

Historic dormers shall be preserved unless documentation of deterioration that justifies the replacement of historic material is provided. Dormer design, proportions, and placement should be compatible in size, scale, proportion, placement and detail with the historic gable and shed dormers found in the historic district. *New dormers in existing roofs are discouraged.*



Historic buildings in Annapolis frequently employed dormers, either as part of an original design concept or as an addition to utilize attic space. Pediment dormers were generally used on gable and hipped roof buildings, shed dormers were used on gambrel roof structures, and segmental arch-headed dormers were employed on mansard roofs.

In neighborhoods where shed dormers or segmental arch-headed dormers occur, new designs may be based on existing non-gabled designs provided they relate to the overall scale and proportions of the proposed facade. Dormer placement should be based on historic precedent within the immediate neighborhood of the affected building, and should be set back **two feet** from the wall below. The total overall width of dormer should be no wider than 1/2 of the overall roof width.

D. 12 - Skylights

Small skylights with a low profile may be permitted on roof surfaces other than the primary facade. Skylights will not be approved on front roof planes or on roof planes facing Spa Creek or the harbor.

All skylights should be of flat-glazed construction, mounted as close to the roofing as possible. Skylights should be designed as part of the overall fenestration of a building, relating vertically to other openings. Skylights that result in substantial up-lighting of the subject property or adjacent properties will not be permitted.

Skylights and dormers cannot be combined successfully on a roof plane. Skylights should be sized and installed to fit between existing roof rafters to avoid damaging original rafters and weakening the original framing.

GUIDELINES FOR PRESERVING AND PROTECTING HISTORIC WALL SYSTEMS

D. 13 - Historic Masonry

Historic brick and stone masonry shall be preserved, unless documentation of deterioration that justifies replacement of historic material is provided.

Brick is the prevailing masonry material in the historic district. Using English bond, Flemish bond, common bond, and header bond, Annapolis masons demonstrated great skill and imagination in their brickwork.

Historic masonry requires specialized treatment

to be preserved. Repointing is not considered routine maintenance and is therefore subject to HPC review and approval. Although brick units themselves have a long life, mortar joints deteriorate over time and require periodic renewal. Where repointing is required, care should be taken to ensure that the mortar mix selected matches the properties of the original mortar, that the brick is not damaged in the process of removing deteriorated pointing, and that the new mortar matches the color, texture, and tooling of the original mortar. Mortar match approvals by the Historic Preservation Commission will be made only on the basis of test panels applied to actual brickwork.

Exterior paint on existing buildings should be spot tested to determine the approximate date that

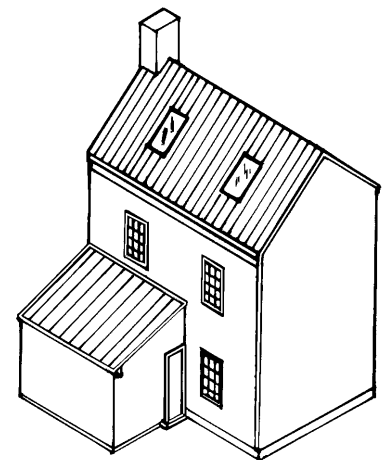
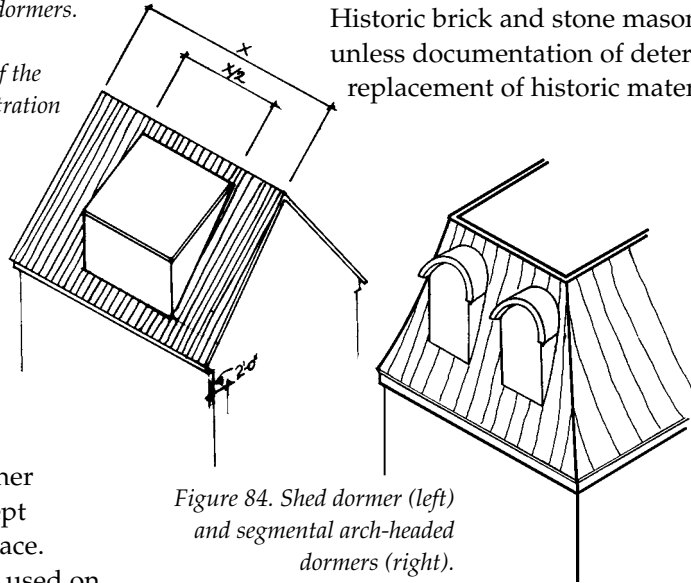

Figure 85. Skylights are not approved on roof planes visible from a public way.

the brickwork was painted and the condition of the original brick below. If a masonry building has been painted in the past, re-painting may be permitted. Only under certain circumstances may exposed brick be painted for the first time.

Prior to undertaking paint stripping operations, the Commission must review and approve a paint stripping test panel to assure that no damage is caused to the brick during the cleaning process. Application of water-repellent coatings or other sealants is not permitted.

D. 14 - New Masonry

The brickwork of building additions should be compatible with the brickwork of the existing building. The brickwork of new buildings should be compatible with the type and color of brickwork that is prevalent in the immediate neighborhood.

Many brick buildings in Annapolis are constructed of handmade sand molded bricks, which were a shade of red. The color, size, and texture of new bricks should be compatible with the brick colors found on historic buildings in the district. Modern extruded bricks, which lack the texture and variation of sand molded bricks, are generally not appropriate.

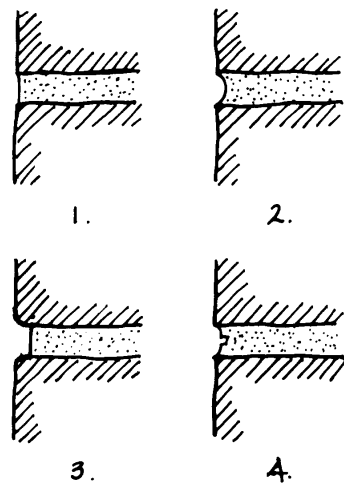

Figure 86.
Details of mortar joints in brick masonry:
1) Flush joint,
2) Concave,
3) Slightly recessed - struck flat,
4) Ruled (Scribed)

D. 15 - Wall Siding and Trim

Historic siding materials shall be preserved unless documentation of deterioration that justifies the replacement of historic material is provided. New replacement siding materials should be appropriate to the style of the building and consistent with existing buildings in the immediate neighborhood.

The choice of siding for many Annapolis buildings was a deliberate design decision, based on a combination of architectural fashion, availability, and cost. The visual character created by the texture and pattern of light and shadow shall not be altered by the replacement of any historic siding with different siding

profiles or non-historic siding materials. The repair of existing historic siding is preferred to replacement. Where the HPC determines that repair of existing siding is no longer feasible, replacement siding should replicate the existing material.

The siding used on additions should complement the siding of the existing building. Siding materials on new buildings should be compatible with traditional siding found within the immediate neighborhood of the new building.

Synthetic substitutes for wood siding and trim are not appropriate in the historic district.

GUIDELINES FOR PRESERVING AND PROTECTING WINDOWS AND DOORS

D. 16 - Historic and Replacement Windows and Doors

Historic windows and doors shall be preserved in place unless documentation that justifies replacement of the historic material is provided. Historic windows shall be repaired by means of consolidation, Dutchman repairs and other restoration techniques. When deterioration is too severe for the window or door to be practicably restored, new replicate windows or doors shall be fabricated. The

new units shall duplicate the historic sashes, glass, lintels, sills, frames and surrounds in design, dimensions, and materials. Existing inappropriate replacements for previously-removed features may

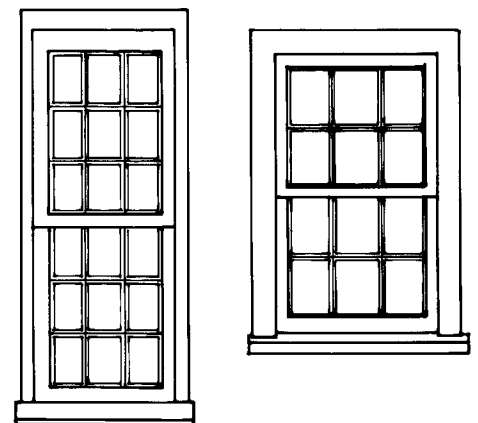

Figure 88. Traditional double-hung sash windows in Annapolis.

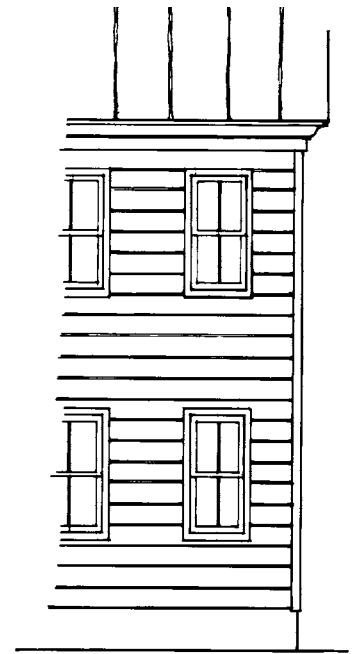

Figure 87. Elevation showing siding and traditional components.

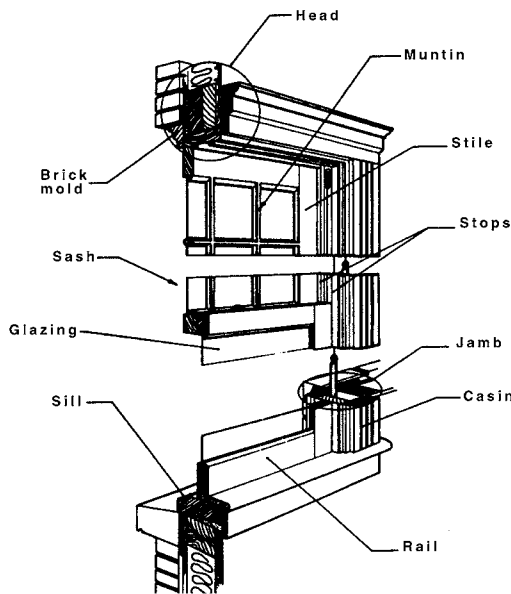

Figure 89. Anatomy of double-hung sash window. New divided light windows should employ integral muntins, not applied muntin grid. (Drawing from *Repairing Old and Historic Windows by the New York Landmarks Conservancy, Washington, DC: The Preservation Press, 1992*)



Figure 90. The proportions of doors and windows create a harmony among historic buildings which should be respected in new buildings. (Drawing courtesy of Historic Annapolis Foundation.)

be replaced with historically appropriate replicas. Vinyl and metal clad replacement windows are not permitted. Sliding glass doors with large uninterrupted sheets of glass are not appropriate.

Annapolis enjoys a wide range of historic window types, ranging from the plank frame windows of the Sands House to the monumental windows of the Capitol to the Victorian storefronts along Main Street. Some late nineteenth century houses in Annapolis have windows with sashes fabricated in a one-over-one or two-over-two pattern at the front elevation and six-over-six sashes in the side and rear elevations. Where such a differentiation exists, it should be preserved. Likewise, one-over-one or two-over-two pattern sashes should not be replaced with six-over-six sashes simply because the small pane windows exist elsewhere on the building.

Occasionally in late nineteenth and early twentieth revival styles, windows featured multi-pane upper sashes and single pane lower sashes. Such a deliberate design decision, usually reflecting a first quarter of the twentieth century construction date, shall be retained. Only clear paned, non-tinted glass shall be used (except

to replace original stain glass). Mirrored and tinted heat reflective glasses are not appropriate.

Exterior storm windows will not be approved for windows with arches, leaded glass, faceted frames or bent glass. Exterior combination storm windows that address heat retention issues may be acceptable provided the installation has minimal visual impact on the original fenestration. Storm windows shall have narrow perimeter framing which does not obscure the glazing of the primary window. The meeting rail of the primary

window must align with that of the storm sash. The painted finish on the storm window frame must match the color of the window trim. Interior storm windows are an appropriate alternative to exterior combination storm windows. Replacement of missing doors and windows shall be substantiated by physical, documentary, or pictorial evidence.

D. 17 - New Openings in Existing Buildings

New window and door openings in existing exterior walls are discouraged.

The placement and size of window and door openings in a historic building are determinants in the scale, rhythm and formality of a building. New openings in a wall alter those qualities, which established the building's character. Where recent changes have altered original fenestration openings, restoration of the original window placement is encouraged.

D. 18 - Windows and Doors in Additions

Windows and doors in an addition to a historic building should relate to the scale and proportion of original openings in the existing building.

While existing windows do not require duplication in a proposed addition, new windows should be in scale with both the addition and the existing windows. Proposed sash patterns should repeat or be sympathetic to the sash pattern of the

existing building. **Sliding glass doors with large uninterrupted sheets of glass are not appropriate.**

D. 19 - Windows and Doors in New Buildings

Windows and doors in new buildings should relate to the scale and proportion of openings on buildings in the immediate neighborhood and to the design of the new building. The allowable percentage of glass permitted on a building facade depends upon the individual building, and cannot be established by a fixed percentage of wall area. It may also be constrained by life safety code requirements, depending on the side yard setbacks. The HPC makes its decision on a case by case basis.

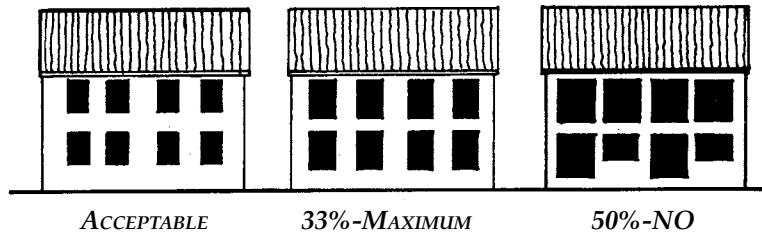

Figure 92. Amount of glass acceptable on a building facade. Glass area in excess of 33% is not compatible with existing buildings in the historic district.

In proposed new buildings, windows should relate to the proportions of the facade, which in turn should follow the scale and proportions of existing, neighboring buildings. Special attention should be given to ensuring that any proposed new windows are in scale with windows in adjacent historic buildings, that the proportions of the windows are visually harmonious with the overall composition of the facade, and that installation details for proposed windows follow historic precedent. Windows should not be horizontal or vertically linked together by structure, trim, or ornamentation.

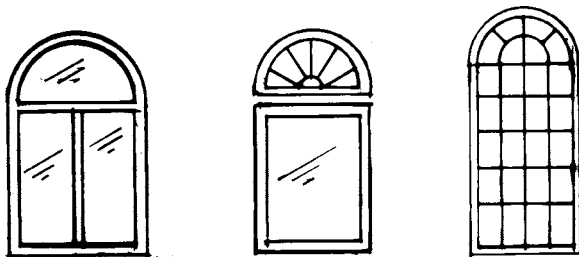

Figure 93. Examples of inappropriate window openings and window types in new construction.

Non-traditional window types, such as combination awning or hopper windows, non-traditionally shaped casement or double-hung sash windows, and curved or polygonal projecting oriel (bow) windows should be avoided.

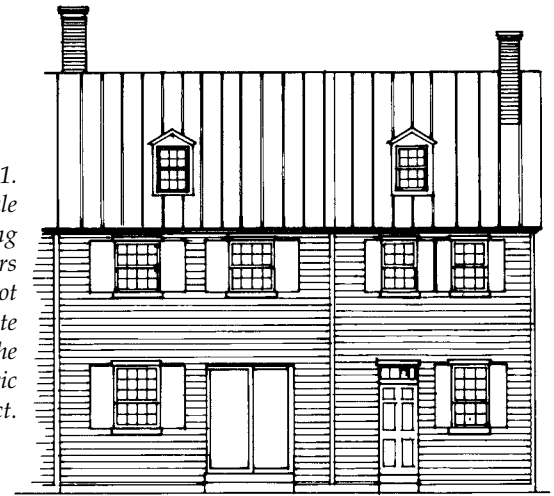

Figure 91. The scale of sliding glass doors is not appropriate in the historic district.

D. 20 - Window Sashes

For new and existing buildings, all proposed sash muntins (glazing bars) should be true muntins, not “snap-in” grids applied to a single sheet of glass. **Removable, internal or snap-in window muntins are not permitted**, and in no case will any type of removable or internal divider be approved.

In some cases, a simulated divided light window with more compatible muntin profiles may be considered for non-historic window replacement or new additions. This does not include insulated glass windows with highly reflective aluminum or exaggerated muntin widths.

D. 21 - Existing Exterior Blinds and Shutters

Historic shutters and blinds shall be preserved unless documentation of deterioration that justifies the replacement of historic material is provided.

Solid panel exterior shutters were typical on pre-1780 buildings, fixed louver blinds on Federal period buildings, and movable louver blinds on Greek Revival and later styles. After World War I, buildings imitative of earlier styles featured shutters or blinds.

Where historic exterior shutters and blinds survive, they should be carefully preserved and repaired. If no shutters or blinds are present but there is evidence that they once existed (as evidenced in either historic photographs or surviving hardware), they can be installed as part of any proposed rehabilitation project. If no evidence exists for shutters or blinds, they should not be added to the building.

Figure 94. New shutters should be sized exactly to each window and hung on traditional shutter hardware.

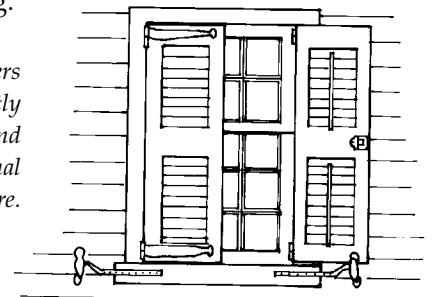

Replacement shutters and blinds should be custom sized to each opening so that the pair entirely closes the opening in the plane of the window frame. Shutters shall be hung on existing repaired hardware (including pintles, hinges, shutter dogs, and sliding bolts) or accurate reproduction hardware where original hardware no longer survives. Shutters shall not be mounted on the outside casing of the window frame, and shall be fabricated of painted wood and **not of vinyl, composition materials, or aluminum.**

D. 22 - Shutters and Blinds on Additions and New Buildings

Shutters and blinds are generally not appropriate on additions and new buildings because the majority of historic Annapolis buildings did not feature shutters or blinds. In some contexts, based on the overall design of the exterior, it is possible that new shutters meeting the criteria above for replacement shutters could be appropriate.

GUIDELINES FOR PRESERVING AND PROTECTING OTHER HISTORIC BUILDING FEATURES

D. 23 - Existing Porches and Stoops

Historic porches and stoops should be preserved in place unless documentation of deterioration that justifies the replacement of historic material is provided.

For many vernacular buildings, the front porch is the most important visual and decorative building element in front of a simple building block. For several streetscapes in Annapolis, front porches are the primary architectural feature of the street, articulating a continuous building row into individual dwelling units. The human scale of a porch also reduces the apparent size of a building.

It is important that surviving porches retain their original form and materials. Porches on the front or

primary façade shall not be enclosed. Deteriorated porches and stoops should be repaired in kind. Wrought iron replacements of wood posts and railings are inappropriate in Annapolis, as are concrete or brick replacements of steps and platforms. The stoops of eighteenth and early nineteenth century houses were usually constructed of wood with wood steps, while freestanding stairs were more often stone. Replacement porches, stoops, and stairs should be based on physical evidence or historic photographs. Where original elements or historic photographs do not survive, replacement porches and stoops should be simple, without elaborate detailing.

Open porches located on a secondary or rear façade may be enclosed if the design is appropriate and visually relates to the building. Enclosure of second and third floor porches is discouraged. Decks located over historic porches are not permitted.

D. 24 - Porches on Additions and New Buildings

On blocks where porches or stoops occur on most buildings, new building designs may incorporate porches or stoops that are similar in scale to existing designs.

Proposed additions which include porches should be simple in design and related visually to the existing building and proposed addition. Where a porch is included in a proposed new building design, it should relate visually to the proposed building in the same way as historic additions relate to existing buildings within the immediate neighborhood. These additions are typically subordinate in scale and material such as a wood addition on a brick house.

D. 25 - Chimneys

Historic chimneys shall be preserved unless documentation of deterioration is provided that justifies replacement. If necessary they may be rebuilt as replicas. Chimney placement and design are

important architectural features of historic buildings, warranting careful documentation and preservation.

Replacement chimneys in existing buildings should be accurate reproductions of original chimneys, based on physical evidence and historic photographs. Where interior chimneys are removed as part of a proposed alteration, chimneys deemed to be significant by the Commission should be reconstructed at the exterior in order to preserve the exterior historic appearance of the building.



Figure 95. Details of entrance stoops.

D. 26 - Ornamental Iron Work

Existing ornamental ironwork, historically used as railings, grilles and fences, shall be preserved unless documentation of deterioration is provided that justifies the replacement of historic material. New metal grilles and railings should be simple in design except where replicating an existing pattern on an existing building. Commercially available decorative cast iron patterns should be avoided on both existing and new buildings.

Where historic ironwork survives, it should be carefully preserved. Decorative period ironwork is not recommended for additions and new construction. Simple painted steel grilles, however, may be an appropriate part of an overall design.

D. 27 - Street Address Numbers

Street address numbers are required on all buildings by the fire department and the United States Postal Service. Simple type styles are preferred. Cursive styles and scripted numbers should be avoided. Numbers should be in scale with and of materials compatible with other design elements on the facade. For existing masonry, the method of mounting street numbers should not damage historic masonry. Anchor bolts should be set in the mortar joints, not bricks.

D. 28 - Use of Contemporary Materials

Use of contemporary synthetic or fiberglass moldings, trim, and columns is not acceptable. Vinyl siding and trim, aluminum siding and trim, and cementitious synthetic wood siding obscure the original character, and may change dimensions of scale defining elements of the building. **Synthetic stucco products such as the Exterior Insulation and Finish Systems (EIFS) are not acceptable.**

Aluminum engineered wood products and vinyl or plastic siding and trim, along with cementitious synthetic wood products shall be avoided. Materials that seek to replicate historic elements such as contemporary synthetic fiberglass moldings, trim, and columns should be avoided, as well as the use of aluminum, engineered wood, and or vinyl or plastic siding and trim along with cementitious synthetic wood products.

D. 28a - Historic Buildings

Original materials shall be preserved in place where feasible. Deteriorated materials should be repaired rather than replaced. The covering over of original building materials is inappropriate.

Where damaged beyond repair, material should be replaced in accordance with guideline D.6. Replacement elements should match the original in composition, scale

and finish. This is especially important around door and window openings.

D. 28b- Additions

Materials used in building additions should be compatible with materials used on the existing building, and should be appropriate to the style and consistent with the character of the original building.

Aluminum engineered wood products and/or vinyl or plastic siding and trim, along with cementitious synthetic wood products shall be avoided.

D. 28c - New Buildings

Materials used in new buildings should be compatible with materials used on buildings in the immediate neighborhood. Materials used on new buildings should be appropriate to the scale and character of surrounding structures. Materials that seek to replicate historic elements such as contemporary synthetic fiberglass moldings, trim, and columns should be avoided, as well as the use of aluminum, engineered wood, and or vinyl or plastic siding and trim along with cementitious synthetic wood products.

GUIDELINES TO FACILITATE COMPATIBLE LIGHTING AND EXTERIOR LIGHTING

D. 29 - Utility Meters and Connections

All applications in which service locations and connections are being modified or installed shall show the proposed service locations. Utility meters and connections mounted on visually prominent walls detract from the historic character of the building and the district. Placement of utility meters, service locations, wires, piping, boxes, and conduits should be in unobtrusive locations. Placement of utility meters on the inside of structures is encouraged where possible

D. 30 - Exterior Lighting

Exterior lighting should not obscure or cause the removal of historic architectural features. Exterior lighting should not wash over the building façade. It is suggested that utilitarian lighting fixtures be painted the predominant color of the building.

Exterior lighting can be much more than mere passive illumination. Exterior lighting can be an architectural element in and of itself. In general, the primary concern is with the intensity of the light. A certain amount of exterior illumination is required for simple safety reasons (20 cp at 6' - 2 cp at 20' is adequate). Care must be taken that nighttime lighting does not produce inappropriate glare or misdirected



Figure 96. View of 203-207 Main Street in the 1920s. (Pickering Negative Collection, Maryland State Archives, MSA SC 1936-1134A)

light. Lighting which detracts from the appearance of the district is discouraged. Exterior lighting should be simple in character and in scale with the building. Up-lighting is generally inappropriate in the historic district.

D. 31 - Historic and Reproduction Light Fixtures

Where historic light fixtures survive, they shall be preserved in place unless documentation is provided of deterioration that justifies the replacement of historic material. Reproduction light fixtures should be historically accurate and compatible with the period of the historic building to which they are attached. The scale and finish should not detract from the architectural character of the building.

Although twentieth-century Colonial Revival houses were often built with “period” light fixtures as part of their original design scheme, period lighting is discouraged for other existing buildings unless documented evidence for a particular type of fixture survives. Where period lighting is desired by a building owner, the fixture selected should be a documented period reproduction accurate to the period of the building and the scale of the building wall or element to which it is attached.

D. 32 - Lighting of Additions and New Buildings

Exterior lighting of additions and new buildings should be simple and in scale with the building. New fixtures should be simple, unobtrusive fixtures mounted in a traditional manner. Recessed down lights, if proposed, should be placed to avoid dramatic light patterns on the proposed building facade. Fixtures should be in keeping with the scale and proportions of a proposed facade.

GUIDELINES FOR STOREFRONTS

Introduction

The design of storefronts along commercial streets greatly affects the scale of the streetscape and can be

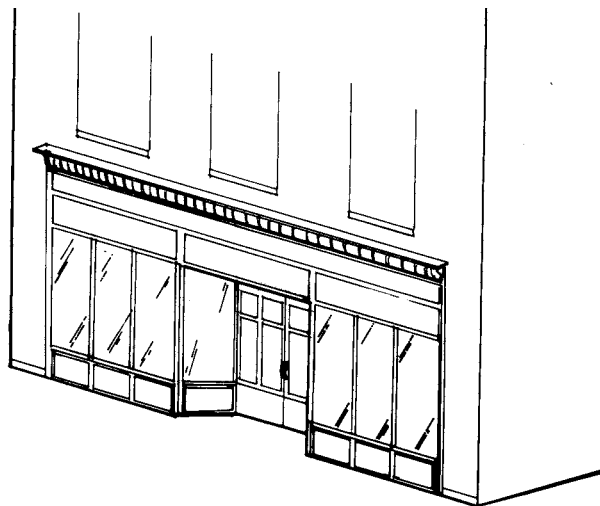

YES

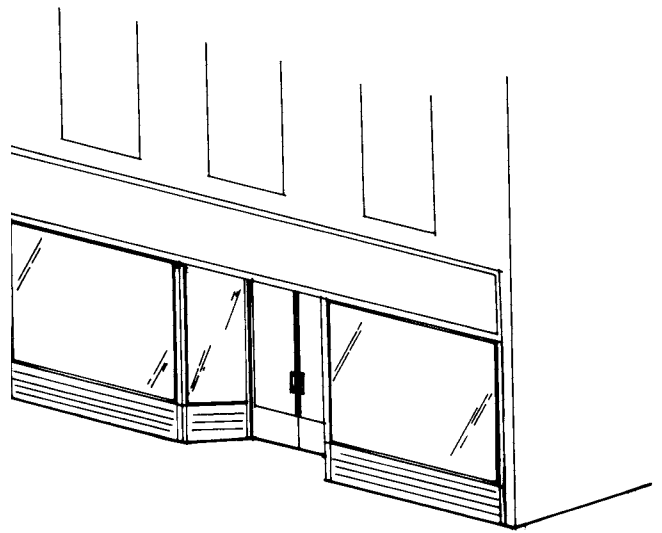

NO

Figure 97. Two storefront designs for the same building. The left design is not a literal reproduction of a period store, but its scale relates to historical storefronts. The right storefront lacks human scale.

one of the most distinguishing and satisfying features of retailing in a historic environment. Surviving historic storefronts shall be preserved.

Until the development of plate glass in the 1850s, windows constructed for the display of merchandise differed little from residential apertures. The availability of large sheets of glass coincided with changes in retailing brought about by the industrial revolution, and storefront alterations were common in the second half of the nineteenth century. In place of traditional multi-pane fixed or double-hung sash windows set in masonry or frame walls, large display windows divided by wood and sometimes cast iron columns appeared. As time progressed, display windows became larger while the structure supporting the upper portion of the front facade became less visible.

D. 33 - Historic Storefronts

Historic storefronts shall be preserved unless documentation of deterioration is provided that justifies replacement of historic material.

Existing historic storefront windows and doors should be retained and repaired, as extant storefronts provide a distinctive character for the commercial area within the historic district. Unfortunately, most existing commercial buildings have experienced several generations of storefront renovations. Where photographic or other graphic documentation for an earlier storefront exists, it is recommended that the earlier design be reconstructed.

D. 34 - New Storefronts in Existing Buildings

New storefronts in existing commercial buildings should be based on physical or photographic evidence.

In existing commercial buildings, new storefront designs shall be based on the historic storefront which formerly existed at that location, as evidenced by surviving physical evidence and historic photographic views.

Where no evidence exists, the new storefront should not be a detailed conjectural reproduction, which could be misconstrued by the public as an authentic, historic storefront. The new design should reference the historic pattern of storefront components, fenestration and materials for its period.

D. 35 - New Storefronts in Additions and New Buildings

Storefronts in additions and new buildings should be compatible in scale, proportion, design, and detailing with storefronts in their immediate neighborhoods.

Storefronts should not be elaborately detailed conjectural reconstructions utilizing period moldings. It is recommended that the proposed design take into

account the design of former storefronts on the property.

D. 36 - Awnings

Awnings should be appropriate to the design of the storefront or building. Awning edges should be free flowing to discourage the impression that the awning is part of the structure. Retractable awnings are encouraged. Awnings should be fabricated of non-reflective canvas, flame resistant in accordance with the building codes.

D. 37 - Signage

Signs should be compatible with the scale, proportions, form and architectural detailing of the building to which they are applied.

Signage within the Historic District is regulated by the Annapolis City Code (Chapters 17.60 and 21.70) and the *Annapolis Historic District Design Guidelines for Signs*, available at www.annapolis.gov.

GUIDELINES FOR ARCHAEOLOGY

Introduction

The following guidelines, derived from practices developed across the United States since the late 1960s, provide a process whereby archeological sites and artifacts reflecting the City's cultural and historical heritage can be protected, or the information they contain salvaged, without restricting unduly improvements to lots within the Historic District or to historic landmarks designated within the City. Archeological examinations are relatively inexpensive when addressed early enough in the planning process.

E. 1 - Conditions Requiring an Archeological Study

City preservation staff, in consultation with the Historic Preservation Commission's archeologist, shall evaluate each proposed project to determine whether it meets one or more of the following conditions:

- a. Does the proposed project disturb more than 50 square feet of soil, regardless of the depth of the excavation?
- b. Does the proposed project disturb a lot with a known archeological site or will it be taking place adjacent to a lot with a known archeological site?
- c. Does the proposed project cause ground disturbance at a location possessing environmental or historical characteristics indicating a high potential for cultural resources?

The City's preservation staff may conduct a site visit and, at its discretion and with property owner's

permission, authorize the Commission's archeologist to conduct limited archeological testing to determine whether additional testing shall be necessary. The costs of testing by the Commission's archeologist shall be borne by the Commission. Based on the findings of the Commission's archeologist, a permit applicant still may be required to retain a qualified archeologist to undertake additional archeological study.

Based on the best available evidence, the City's preservation staff may determine that the proposed project will have no adverse effect on historically significant archeological artifacts or deposits. The City's preservation staff shall then recommend to the Commission that no further archeological investigation be required in connection with the permit application.

Based on the best available evidence, the City's preservation staff may determine that the proposed project might have an adverse effect on historically significant archeological artifacts or deposits. The City's preservation staff shall then recommend to the Commission that the applicant retain the services of an archeological consultant who meets the criteria established by the Secretary of the U.S. Department of the Interior.

E. 2 - Archeological Study

If the Commission determines that an application requires archeological review, the applicant shall retain a qualified archeological consultant. The applicant shall submit the consultant's report to the Department of Planning & Zoning. The City's preservation staff will evaluate the consultant's findings and recommendations. The report shall include:

1. A brief history of the lot or lots under consideration, including preliminary cartographic research
2. A map showing the extent of the proposed project and the locations of archeological test pits
3. A clear description of the archeological survey's methods and results, including, but not limited to: soils and stratigraphy; nature and extent of archeological features and deposits; and nature and extent of recent disturbances of those features and deposits
4. Illustrations of the project area and of soil layers and archeological features
5. An artifact catalogue
6. Recommendations regarding the historical significance of the archeological findings and for additional archeological study, if appropriate.

If no intact archeological deposits are identified, the archeological consultant may submit a one page

summary report with a map noting the locations of the excavation units that has the recommendation of the Commission's archeologist, and the administrative approval of the Chief of Historic Preservation. With the approval of the Commission, this summary letter and map can serve in lieu of a fuller technical report, thereby reducing costs for the applicant. The preservation staff will review and comment on the report or summary letter within thirty days of receipt.

The archeological consultant, whether submitting a full-length report or a summary letter, will address the following questions:

1. Based upon available information (archeological, cartographic, and archival), are archeological deposits present within the proposed project area?
2. If so, do those deposits retain sufficient integrity to provide important information about the area's history?
3. Do the deposits contribute to the National Register District based on the National Register for Historic Places criteria?

E. 3 - Sites Deemed Historically Significant

If the Commission determines that a project will adversely affect a contributing National Register or locally designated landmark site, the applicant shall have the option to revise the project plan to avoid the site. If avoidance is not feasible, the Commission shall:

1. determine whether the adverse effect can be mitigated through protective measures (*e.g.*, filling, use of pier-construction rather than a continuous foundation); or
2. if protective measures are not feasible, require and specify the scope of archeological salvage; or
3. deny a Certificate of Approval for the proposed project because it constitutes unwarranted destruction of a historically significant archeological site.

In consultation with the City's preservation staff, the Commission can approve additional archeological excavation to recover the kinds of artifacts and information for which the site is considered historically significant. The applicant shall submit a scope of services to the City's preservation staff.

E. 4 - Archeological Salvage

'Salvage' means to save from extraordinary danger, to recover something of value in the face of unavoidable destruction. Archeological salvage is a plan of last resort, where in-place preservation of an archeological site is not feasible because:

1. The costs of preserving that site in place are unreasonably high;
2. Natural forces preclude reasonable attempts at preservation (*e.g.*, shoreline erosion); or
3. Other public needs outweigh the value of the historically significant site.

Archeological salvage consists of recovery, analysis, interpretation, and reporting of those data for which the site is considered historically important. For example, trash deposits in the back of a late 19th-century grocery might be considered historically significant because they contain information on the city's place in the rapidly growing consumer economy of the period. Those finds also could be critical to the interpretation of archeological deposits from the same period elsewhere in the city, illuminating the different standards of living and cultural differences among the City's ethnically diverse population. Salvaging such deposits might involve excavating enough of the deposits to acquire a scientifically and statistically valid sample. The Commission might permit the destruction of the remaining deposits, even if those deposits equal or exceed in volume the quantity of material salvaged.

The applicant's archeological consultant will undertake salvage within the proposed construction project area with a scope of work approved by the Commission and the City's preservation staff. The scope of work will include a research design specifying the questions to be asked of the archival and archeological data and the methods selected for collecting and analyzing those data in a manner appropriate to the questions. The applicant's consultant will keep the preservation staff apprised of progress, significant findings, or unanticipated problems via telephone or personal visit. All such reports must be reiterated in a written memorandum to the City's Chief of Historic Preservation within twenty-four hours of the oral report. The City's preservation staff shall make status reports to the Commission as needed. The Commission and the City's preservation staff reserve the right to visit the excavation with one-hour prior notice. Excavations shall not be backfilled without the prior notification and approval of the preservation staff. All excavations will conform to good standard archeological practice, and the intention to so comply shall be clearly specified in the scopes of work.

The applicant shall submit the consultant's report to the Department of Planning & Zoning. The City's preservation staff will evaluate the consultant's findings

and recommendations. The report shall include:

1. Historical background on the lot or lots on which the research is carried out;
2. Location information, including a map showing the extent of the proposed project;
3. A clear description of research questions and methods;
4. A clear description of results, including, but not limited to: illustrations of archeological test pit locations and stratigraphy; descriptions of the nature and extent of archeological features and deposits; descriptions of the nature and extent of recent disturbances of those features and deposits; and illustrations of artifacts and features crucial to the analysis and interpretation of the site;
5. Analyses sufficiently detailed and statistically supportable to demonstrate that the data for which the site is considered historically significant have been adequately sampled;
6. Interpretations that explicitly relate the analyses and results to the questions posed in the scope of work and in the research design section of the report;
7. A list of cited references in the style of *American Antiquity* or *Historical Archaeology* journals; and
8. An artifact catalogue and such other appendices as seem appropriate.

The preservation staff shall review and comment on the report within thirty days of receipt. The final report shall become a part of the completed permit application and, as such, be subject to the Commission's approval. Three final copies of all archeological salvage reports must be given to the Department of Planning & Zoning. The Department of Planning & Zoning shall forward one copy of each report to the Maryland Historical Trust as part of its Certified Local Government report.

Collections

The Commission encourages all permit applicants to donate artifacts, notes, photographs, and other materials assembled during the course of permit-mandated archeological studies to locally recognized collecting institutions. These might include, but are not limited to, the Maryland Historical Trust and Historic Annapolis Foundation. All archeological consultants are required to prepare collections in a manner consistent with the practices of local collecting institutions.

Historic District Sign Guidelines

INTRODUCTION

The installation of any sign in the City of Annapolis is subject to the review and approval of the Department of Planning and Zoning and the Department of Neighborhood and Environmental Programs. In addition, any new sign or any existing sign that is to be altered in size, shape, content or location that is presently or is to be situated in the Annapolis historic district must receive a Certificate of Approval from the Historic Preservation Commission. The Historic Preservation Commission is not responsible for compliance with the zoning code, which regulates by ordinance: size, number of signs per property, projection and height; or with the building code, which regulates sign materials and methods of attachment to façade. The Commission is responsible for the review of applications for all new signs and for all existing signs to be altered that are located in the historic district with regard to: shape, location or placement, texture, lettering style and other graphic devices, message, lighting, appearance of fixtures used to attach signs, and overall visual impact. The review process will include analysis of a proposed sign as it is related to the facade to which it is to be affixed, to contiguous facades, and to other facades in the immediate vicinity. Zoning requirements regarding signs located in any one of the eight zoning classifications that are present in the historic district are detailed in the appendix to this report. These statutory requirements are regarded by the Commission as ‘maximums’ for area (size), number of signs, projection and height. Since the appropriateness of a sign is not solely a function of size or height, satisfying the criteria does not guarantee acceptance by the Commission. The Commission is not obligated to approve zoning code maximums, and may be more restrictive. In an attempt to assist property owners, tenants, designers and sign manufacturers, and to facilitate review by the Historic Commission, the following guidelines have been prepared for signs in the historic district.

The Guidelines were adopted by the Historic Preservation Commission on March 27, 2008.

DEFINITION OF A SIGN

Chapter 21.70 of the Annapolis City Code provides the following definitions of signs:

21.72.010 Sign. “Sign” means any name, identification, description, display or illustration which is affixed to, or represented directly or indirectly upon, a building, structure or piece of land, and which directs attention to an object, product, place, activity, person, institution, organization or business. The term “sign” includes signs erected or installed in the interior of a structure if the sign is situated in a manner to indicate that its



prime purpose is for viewing from the exterior of the structure. The prime purpose of an interior sign is exterior viewing if it is visible from the exterior and if no public access is permitted between the sign and the exterior window of the structure. The term “sign” does not include any display of official court of public office notices, nor does it include the flag, emblem or insignia

of a nation, political unit, school or religious group, nor does it include the official name, permanently affixed to the structure, of any educational, cultural or religious institution. "Sign" does not include a sign located completely within an enclosed building and not visible to the outside of the building. "Sign" does not include a temporary sign (Prior code §21.04.545).



Example of a well designed sign

21.72.010 Sign, temporary. "Temporary sign" means a sign which advertises community or civic projects or special events on a temporary basis, or a political sign. Temporary signs for community or civic projects or special events shall be allowed only for events of public interest (such as fairs, carnivals, community gatherings) and other events of a similar nature. Signs greater than twenty (20) square feet in area shall be permitted only upon written approval by the Department of Planning and Zoning. Temporary signs shall only be displayed for a period not in excess of sixty (60) days and shall be removed within seven (7) days after the conclusion of the event (Prior code §21.04.570).

GENERAL GUIDELINES

1. The Commission will review each sign application as a unique case. The Commission will not attempt to establish specific criteria of standards to which each and every sign proposed for the historic district must conform.
2. Well-designed signs are needed for communication and identifying goods and services. Signs are artifacts in themselves. They are a significant component of the environment. Signs affect the quality, image and cohesiveness of the entire historic district. Therefore, each sign should contribute to the visual character

and harmony of the historic district, be compatible in scale, and increase the efficiency of communication.

3. In general, single faced, flat signs affixed directly to a building façade are preferred. Projecting or other hanging signs are acceptable only if they are designed to be compatible with the design of the façade. If there is more than one sign on the building the hanging sign should compliment the others. Free standing, raised lettering applied directly to a wall or signboard may also be appropriate, depending on size of type and placement. Projecting or other hanging signs, if otherwise considered acceptable, may be double faced if desired, or single faced if the obverse side is finished in a manner compatible with the finish of the facades. Symbolic two or three dimensional signs may be permitted if they identify the product or service available at that location, and otherwise conform to the city regulations and these guidelines. Freestanding signs may be approved if they are of a permanent nature and are used to identify public offices or other conveniences, or if they offer an alternative to multiple signs.
4. All signs in the historic district must be directly related to the businesses, services or products offered within the premises. Signs unrelated to the property where they are to be located, with the exception of temporary signs, public information, emergency notices and other signs specifically identified in the zoning code, will not be approved. Simplicity of a sign is important to its legibility and effectiveness. Therefore, the Commission will not approve supplementary advertising, redundant messages or unnecessary slogans.



A sign should contribute to the visual character of the entire historic district.



Above: example of free standing, raised lettering applied directly to the wall.



Right: exaple of acceptable hanging projection sign.

rather than cover or disturb design features such as rhythm, fenestration (the pattern of window to wall, solid to void), and scale. There are logical surfaces on virtually every building in the historic district where signs may be located. Often these “signable areas” will include a continuous flat wall surface free of window or door openings or other architectural features—areas between the top of a storefront and the sills of the second floor windows, sign boards designed for such use and already in place, panels at the top of show windows, and transoms over doors and windows. Examples of so-called “signable areas” as they exist on Annapolis buildings are included with these guidelines to illustrate desirable locations and the placement of a variety of signs. In some cases, a particular façade may offer more than one sign area, usually totaling more square footage than permitted under

the zoning code. Therefore, the applicant will be required to identify a specific location and size with his request for review by the Commission. If requested by the applicant, the Commission will assist in identifying appropriate locations and sizes for a specific building façade.

3. **Shape:** The predetermined “signable areas” discussed above will in most cases dictate the preferred shape of a sign for that particular façade. Sign boards built into many storefronts are rectangular (or are a connected series of rectangles), as are transom lights over doors and the upper parts of show windows, and especially the wall surfaces between the first floor shop front and second floor windows.

5. The Annapolis Historic District is pedestrian oriented. With the obvious exception of traffic and other informational signs directed at the motorist, all signs should be related to the pedestrian’s scale of perception with regard to size and placement of lettering.
6. The Commission considers the quality of a sign as a mirror of the environmental and visual quality of the historic district as a whole. Quality will be considered as an important factor in the Commission’s review process. Signs will be judged on the appropriateness of design, lettering size and style, shape of signboard, fabrication and manufacture, materials, installation, and lighting, if any.

SPECIFIC GUIDELINES

1. **Size and Height:** The allowable height and square footage of signs in the historic district is regulated by the Department of Planning and Zoning—the specific requirements are included in the appendix.
2. **Location:** Signs in the historic district should be positioned so that they appear as an integral design feature of the overall façade of a particular building. Signs should relate to, and help define and enhance, the architectural features of the building,



Signable areas shown in black.

Vertical wall areas between windows, doors, and the edges of a façade afford a variety of choices regarding the shape of a sign. While the Commission does not encourage the use of irregular shapes, numerous free-form signs have been approved. Those signs that have been allowed, examples of which are included in the guidelines, are regarded by the Commission as having a definite relationship to the design of the façade of a particular building, to the architectural style or period of the structure, or to a specific use to which the sign is directed. A Victorian sign may not be appropriate on a 1780 façade or on a 1930 building, but the same sign on a late 19th Century structure will almost surely contribute to the overall design and character of that façade. Conversely, a sign that derives its shape from 18th-century design precedents may not be appropriate on a simple, 19th- or 20th-century vernacular structure.

4. **Letter Style (Typeface):** Lettering should be compatible with the use of the building as well as the design of the façade. The Commission does not insist on any particular typeface or style, and may approve any style of lettering selected by the applicant if it is legible. However, as most script styles are difficult to read when used at the scale of most signs, they are discouraged unless they are of overriding importance to the design concept of the sign. Italic or other decorative letter styles may be approved if they relate to the use of the building or to the design of the façade. The consideration of the Commission regarding lettering style is that it be clearly legible, and that its use result in a sign that contributes to the visual quality of the historic district. The size of the lettering should be in proportion to the façade as well as to the sign itself.

5. **Illumination:** Internally illuminated signs are not permitted. Gooseneck lamps are also not permitted in the historic district. Luminaries should be small scale, unobtrusive. Lights should focus on sign, not building façade (see staff for suggestions.)

6. **Method of Attachment:** Like the use of materials, methods of attaching signs to buildings anywhere in the city are governed by the Department of Public Works, whose



Examples of free form shaped signs. These types of signs are not encouraged, but have been approved by the commission.



Examples of potential lighting mechanisms appropriate for the Historic District.



primary concern is public safety. The appearance of supports and fixtures, however, must be approved by the Commission, which will review the design of the supports, their configuration and their relationship to the façade to which the proposed sign is to be attached. As an example, a projecting sign that is not an integral feature of an overall façade design should be attached so that it appears as a separate entity, perhaps by providing space between the sign and the surface where it is to be mounted. Such a sign should not be placed so that the supports or the edge of



Example of a projecting sign.

the sign conflict with any design feature of the façade. The attachment method should also be reversible, minimizing damage to historic fabric.

7. **Color:** While the Commission has no direct control over the selection of colors for use in the historic district, it does recommend that its use be restrained, perhaps limiting a sign to one or two colors applied to a neutral background of a third. The selection of particular sign colors should be governed by the colors of the façade to which the sign is to be attached, and by the use identified by the sign.
8. **Materials:** The Commission is primarily concerned with the quality of the materials proposed by the applicant as it affects the image of the historic district, and recommends simplicity in the selection of sign components. The Commission discourages the use of plastic, extruded metal sections, or sandblasted wood for signs in the historic district.



Example of new materials used to create a sign that is appropriate for the business use and location in the Historic District.

9. **Public Works Requirements:** The specific materials to be used in the fabrication of signs and their supports, and construction techniques, are regulated by the Department of Neighborhood and Environmental Programs. Please see Chapter 17.60 of the Annapolis City Code for the Department of Neighborhood and Environmental Programs requirements specific to the historic district. These include the requirement that all signs must be attached to the building, that signs can not be painted on buildings and that no sign may project more than 24" (note: 18" in C-zone).
10. **Miscellaneous:** The Commission discourages the use of erroneous or passé spelling, like "junque," "olde," or "shoppe," or other devices to attract attention that are unrelated to the historic district or are extraneous to the message of the sign. Similarly, while trademarks and logos can be an

important component of a sign, the Commission is under no obligation to approve any graphic device considered inappropriate to the historic district. While the Historic Preservation Commission can not require that signs be executed by a professional, the quality of the execution of a sign is important and is one of the criteria of approval.

ANNAPOLIS CITY CODE ZONING REGULATIONS

Chapter 21.70 of the Annapolis City Code establishes zoning requirements that all signs erected in the City must meet. There are twelve different zoning districts within the historic district. The requirements for each zone are different. A map to assist you in determining which zoning district your property is located can be found on the city's website at www.ci.annapolis.md.us/upload/images/government/depts/pl_zon/map/index.pdf. On the following pages the sign requirements for each zone are detailed.

21.70.010 Purpose.

The purposes of these sign regulations are to encourage the effective use of signs as a means of communication in the City; to maintain and enhance the aesthetic environment; to promote pedestrian and traffic safety; to minimize the possible adverse effects of signs on nearby public and private property; and to enable the fair and consistent enforcement of these regulations. (Ord. O-1-04 Revised (part), 2005)

21.70.020 Applicability.

No signs except signs exempted by this chapter may be erected unless a sign permit has been issued by the Director of Neighborhood and Environmental Programs pursuant to Chapter 17.60. (Ord. O-1-04 Revised (part), 2005)

21.70.030 Sign permit.

- A. Application for a sign permit shall be made to the Department of Neighborhood and Environmental Programs pursuant to Chapter 17.60. The Department of Planning and Zoning will review the sign permit application for consistency with the Zoning Code.
- B. Posting of Property. Except as provided below, notice must be posted on the property that is the subject of an application for a new sign in accordance with the requirements in Section 21.10.020(A).
- C. Notice of applications for sign permits shall be in accordance with the following requirements:
 1. All sign applications located in the Historic District, the Office and Commercial Design District or the Eastport Gateway Conservation Overlay Districts

shall be posted for public notice.

2. In all other districts, where the sign area applied for is less than twenty-five percent of the maximum sign area allowed for the type of sign under this chapter, posting of the sign application for public notice is not required.
3. Posting of a sign for public notice shall not be required where a sign program has been approved in conjunction with the approval of a Site Design Plan under Section 21.70.080. (Ord. O-22-07 Amended § 1, 2007; Ord. O-1-04 Revised (part), 2005)

21.70.040 Prohibited signs.

The following signs are prohibited:

- A. Animated signs;
- B. Billboards;
- C. Flashing signs;
- D. Portable signs (a sign that is not permanent, affixed to a building, structure or the ground);
- E. Rotating signs;
- F. Rooftop signs;
- G. Signs projecting above the rooflines of buildings;
- H. Snipe signs (non-governmental signs attached to trees or poles). (Ord. O-1-04 Revised (part), 2005)

21.70.050 Standards applicable to all signs.

The following standards apply to all signs whether exempt or permitted:

- A. Condition and Appearance. All signs shall be maintained in good condition and appearance.
- B. Computations of Area and Height.
 1. Area.
 - a. The area of a sign face (which is also the sign area of a wall sign or other sign with only one face) shall be computed by means of the smallest square, circle, rectangle, triangle, or combination thereof that will encompass the extreme limits of the writing, representation, emblem, or other display, together with any material or color forming an integral part of the background of the display or used to differentiate the sign from the backdrop or structure against which it is placed, but not including any supporting framework, bracing, or decorative fence or wall when such fence or wall otherwise meets the zoning regulations in this title and is clearly incidental to the display itself.
 - b. The sign area for a sign with more than one face shall be computed by adding together the area of all sign faces.
 2. Height. The height of a sign shall be computed as the distance from the base of the sign at normal grade to the top of the highest attached component

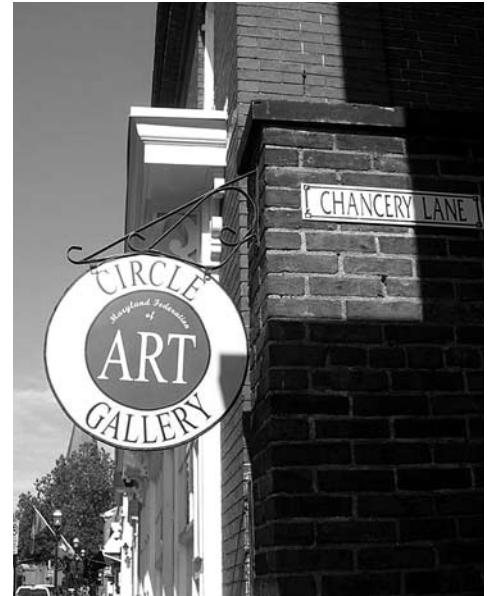

of the sign. Normal grade shall be construed to be the lower of: (1) existing grade prior to construction or (2) the newly established grade after construction, exclusive of any filling, berming, mounding, or excavating solely for the purpose of locating the sign. In cases in which the normal grade cannot reasonably be determined, sign height shall be computed on the assumption that the elevation of the normal grade at the base of the sign is equal



to the elevation of the nearest point of the crown of a public street or the grade of the land at the principal entrance to the principal structure on the zoning lot, whichever is lower.

C. Sight Visibility.

1. No sign shall obstruct a clear view to and from traffic along any street right-of-way, entrance or exit.



2. A sight visibility triangle, as defined in Division VI, shall be kept free of obstructions to vision between the heights of two and one-half feet and twelve feet above the street. If, in the opinion of the Director of Planning and Zoning with the concurrence of the Director of Public Works, there are unusual circumstances, these dimensions may be altered to enhance public safety.

D. Integrated Sign Program. An integrated sign program, as defined in Division VI, is required for all commercial office complexes, shopping centers, and multi-tenant facilities. The establishment of an integrated sign program for existing developments is strongly encouraged.

E. Design. The design of signs is important to the character of the City of Annapolis. The following provisions are designed to give guidance to persons designing, erecting, and approving signs in the City.

1. Guidelines for All Signs.

- a. Materials, colors and shapes of proposed signs shall be compatible with the related building(s). Size and proportions should be judged by sizes and proportions of signs on nearby properties that are compatible with the prevailing character, or the character prescribed in land use plans adopted by the City Council.
- b. Every sign shall be designed as an integral architectural element of the building and site to which it principally relates.
- c. The number of graphic elements on a sign shall be held to the minimum needed to convey the sign's major message and shall be composed in proportion to the area of the sign face.
- d. Each sign shall be compatible with signs on adjoining premises and shall not compete for attention.
- e. Signs should be constructed of quality materials. The choice of materials for signage should relate to the quality of architecture within the zoning district.
- f. Signs should provide information, character and a quality image.

2. MX and BR Districts, Additional Guidelines.

- a. Signs generally shall be of simple design and relate to the scale and design of buildings.
- b. The size of each sign shall relate to the scale and architectural character of its facade.
- c. The placement of signs shall not cover attractive architectural details, overwhelm the facade in size, or interrupt the rhythm of upper facade windows.
- d. The choice of materials for signs shall relate to the quality of historic architecture within the MX district. The use of painted wood, glass and metal are appropriate.

F. Removal of Signs. Any sign associated with an activity on a vacated premises shall be removed from the premises, altered or resurfaced within one month from the time such activity ceases so that the sign does not display visual communication pertaining to the former activity. (Ord. O-1-04 Revised (part), 2005)

21.70.060 Exempt signs.

The signs in this section are exempt from this chapter and do not require a permit provided they meet both the standards applicable to all signs in the previous section and the following standards:

- A. No sign may project beyond the property line into a public way.
- B. Illumination is Not Permitted.
 - 1. Nameplate and Identification Signs.



- a. A single nameplate for a dwelling unit, not exceeding one square foot in area, indicating the name or address of the occupant or a permitted occupation.
 - b. On a corner lot, two nameplates for a dwelling unit, one facing each street, are permitted.
 - c. Address numerals.
2. For Sale and "To Rent" Signs.
- a. One sign per zoning lot except that on a corner zoning lot two signs, one facing each street, are permitted.
 - b. Size.
 - i. In commercial and industrial districts signs may be up to twelve square feet in area.
 - ii. In all other districts signs may be up to nine square feet in area.
 - c. No sign may be placed closer than eight feet to any other zoning lot.
 - d. No sign shall project higher than twelve feet above curb level.
3. Signs Accessory to Parking Areas.
- a. Signs designating parking area entrances or exits limited to one sign for each exit or entrance and to a maximum size of two square feet each.
 - b. One sign per parking area, designating the conditions of use or identity of the parking area and limited to a maximum size of nine square feet.
 - c. On a corner lot two signs, one facing each street, are permitted.
 - d. No sign shall project higher than seven feet above curb level.
4. Temporary signs as follows:
- a. Signs, banners, flags and other advertising devices may be placed on a site or building to announce the opening of a new business or a special promotion with written approval from the Director of Planning and Zoning. Such signs shall be limited to two events per year for a period of up to thirty days each event.
 - b. Temporary signs up to twenty square feet for community or civic projects or special events for events of public interest such as carnivals, community gatherings, fairs, political events and other events of a similar nature. Temporary signs shall be displayed for a period not in excess of sixty days and shall be removed within seven days after the conclusion of the event.
 - c. Construction site sign up to thirty-two square feet identifying the architect, engineer, and/or contractor.
 - d. Garage or yard sale signs.
 - e. Christmas tree, greens sales, and produce sales

signs. One sign per street frontage up to six square feet is permitted.

- 5. Window Displays. Signs erected or installed in the interior of a structure which form an integral part of a bona fide window display which is related to merchandise or services available within the structure or which are related to matters of public welfare or public interest.
- 6. Public Signs.
 - a. Permanent memorial signs and tablets lawfully displayed on public property or in cemeteries.
 - b. Legal notices.
 - c. Traffic and parking signs that bear no advertising. (Ord. O-1-04 Revised (part), 2005)



21.70.070 Signs in residential districts.

- A. General Standards.
 - 1. Illumination is permitted only by external means such as by spotlight.
 - 2. No sign may project beyond the property line into a public way.
- B. Permitted Signs. The following signs are permitted accessory to permitted uses subject to the standards set forth in this section and other general standards set forth in this chapter:
 - 1. Signs for Colleges, Religious Institutions, Schools, and Similar Institutions.
 - a. One freestanding bulletin sign per lot is permitted; except, that on a corner lot, two signs, one facing each street, are permitted:
 - i. Maximum area: thirty-two square feet per face.
 - ii. Maximum distance from any other zoning lot: eight feet.

Sign Table 1
Types of Signs Permitted in Non-Residential Zoning Districts

District	Permitted Signs
B1	Business community identification sign Freestanding Wallmounted
B2, B3-CD, BCE, I1	Freestanding Multi-tenant facility Wall-mounted
B3, BR, PM2	Multi-tenant facility Wall-mounted
C2, C2A, C2P	Wall-mounted
P, PM	Business community identification sign Multi-tenant facility Wall-mounted
MX	Freestanding, ground sign only Multi-tenant facility Wall-mounted
WMC, WME, WMI, WMM	Freestanding Marine refueling facility signs on piers Multi-tenant facility Wall-mounted

corner lot, two signs, one facing each street, are permitted.

- b. Maximum area: two square feet.
- c. Maximum height: fifteen feet.
- d. No sign may be closer than five feet to any other zoning lot. (Ord. O-1-04 Revised (part), 2005)

21.70.080 Signs in non-residential districts.

A. General Standards.

1. An integrated sign program is required for all commercial office complexes, shopping centers, and multi-tenant facilities. Individual signs shall be reviewed for conformity with the integrated sign program whether newly established or existing.
2. Pole signs may have no more than two faces.
3. Two-faced signs must be double faced back-to-back.
4. Signs may not be placed along any side or rear lot line within a required buffer yard.

B. Permitted Signs.

1. Sign Table 1 lists the types of signs that are permitted in non-residential zoning districts.
2. Sign Table 2 sets forth the regulations for permitted signs in non-residential zoning districts. (*See pages 66-69 for Table 2.*)
3. Signs for residential uses, professional offices or studios, colleges, religious institutions, schools, and similar institutions, where these uses are permitted in non-residential zoning districts, are permitted pursuant to the regulations for these signs in residential districts.
4. For drive-thru facilities, in addition to other signage allowed for the specific use, a menu board in the drive-thru lane is allowed as determined appropriate through the site design review process.

21.70.090 Signs in the historic district.

In addition to the requirements of the underlying zoning district, signs in the historic district are subject to the following:

- A. A certificate of approval from the Historic Preservation Commission is required for all new signs and existing signs that are to be altered in size, shape, content or

iii. Maximum height: fifteen feet.

b. One wall-mounted sign is permitted containing the official name of the institution. Maximum lettering height: thirty inches.

2. Non-Residential Building Nameplate and Identification Signs.

a. A single identification sign is permitted, not exceeding nine square feet and indicating only the name and address of the building.

b. On a corner lot, two signs, one facing each street, are permitted.

c. Maximum height fifteen feet.

3. Subdivision or Community Identification Signs.

a. One identification sign, not exceeding twelve square feet, giving the name of the subdivision or community may be placed at each entry point.

b. The sign shall convey no information other than the name of the subdivision or community.

c. Maximum height fifteen feet.

4. Bed and Breakfast Signs. A single sign, not exceeding two square feet is permitted.

5. Professional Office or Studio Signs.

a. One sign per lot is permitted; except, that on a

location, see Chapter 21.56.

- B. Applicants for sign permits in the historic district should refer to the Historic Preservation Commission's design guidelines for signs.
- C. No commercial sign, billboard or other advertising structure or device shall be painted on any exterior wall of a building within the historic district.
- D. Upon the inclusion of additional areas within the historic district of the City, all signs shall comply with this section within two years from the date the area is included within the historic district. (Ord. O-1-04 Revised (part), 2005)

21.70.100 Nonconforming signs.

- A. The Director of Neighborhood and Environmental Programs shall order the removal of any sign erected or maintained in violation of the law as it existed prior to the date of the adoption of this Zoning Code.
- B. Other signs existing at the time of the adoption of this Zoning Code and not conforming to its provisions, but which did conform to previous laws, shall be regarded as nonconforming signs which may be continued if properly repaired and maintained as provided in this chapter.
- C. Nonconforming signs which are structurally altered, relocated, or replaced shall comply immediately with all provisions of this chapter. (Ord. O-1-04 Revised (part), 2005)

21.70.110 Variances.

- A. Pursuant to the authority and procedures set forth in Chapter 21.28, the Board of Appeals may grant variances to the limitations set forth in this chapter with respect to the following:
 - 1. An adjustment of up to twenty percent to the limitations set forth in this chapter with respect to the following dimensional criteria:
 - a. Sign area,
 - b. Height,
 - c. Distance of permitted projection,
 - d. Setback,
 - e. Distance from other zoning lots,
 - f. Height of lettering.
 - 2. An increase of one sign in addition to the maximum number of signs permitted per lot, building, or street frontage.
 - 3. The dimensional criteria set forth above in subsection A of this section.
 - 4. The number of signs allowed per lot, building, or street frontage.

- B. In addition to the review criteria and findings set forth in Chapter 21.28 for variances, the Board of Appeals shall only approve an application if the entire signage on the lot will meet the design provisions set forth in Section 21.70.050(E). (Ord. O-1-04 Revised (part), 2005)

APPLICATION PROCESS

Before erecting a new sign or altering an existing sign in the historic district, it is necessary to obtain a certificate of approval from the Historic Preservation Commission. As part of the processing of an application for certificate of approval, signs will be reviewed by the Department of Planning and Zoning for compliance with zoning code requirements. Application forms are obtainable from the Historic Preservation Assistant in the Department of Planning and Zoning, 145 Gorman Street, 3rd Floor, Annapolis, MD 21401. The application form includes, in addition to the application for certificate of approval, a sign permit application and detailed information on what must be submitted as part of a sign application.



Sign Table 2

Regulations for Signs in Non-Residential Zoning Districts

In using the table the following regulations apply:

- a. Lots are permitted both wall-mounted and freestanding signs up to the limits set forth in the table. Signage in multi-tenant facilities is counted as an alternative, not in addition, to permitted wall-mounted and freestanding signs.
- b. For wall-mounted signs the maximum sign area is for the lot.
- c. For all other signs the maximum sign area is the maximum area per sign face, unless stated otherwise. For example, a two-sided, freestanding, ground sign in the BCE could be thirty square feet per face or sixty square feet total.
- d. The following abbreviations are used in the table: sf = square feet; lf = linear feet; bldg = building; " = inches.

Sign Type	Zoning District	Number of Businesses per Lot	Maximum sign area	Number of signs allowed	Maximum height (feet)	Illumination permitted	Projection permitted	Other
Wall Mounted	B1, BR PM, MX		1. 1sf per ft of building frontage up to a maximum of 100 sf. 2. No single sign may exceed 30 sf per face	1. B1, PM: no limit, up to maximum permitted sign area 2. BR, MX: no more than 3 signs per building	13. In the MX district, signs may not be located higher on a facade than the second-story windowsills	Yes, external means only such as spotlight	Yes, up to 1.5 feet from a wall	
	B2, B3, B3-CD,		1. 2sf per lf of building frontage up to a maximum of 120sf. 2. No single sign may exceed 75 sf in area	No limit up to permitted sign area	15	Yes	Yes, up to 1.5 feet into a public way	Uses with canopies, such as service stations, may use the lf of canopy frontage in lieu of lf of building frontage to calculate permitted sign area
	C2, C2A, C2P		1sf per lf of building frontage up to a maximum of 30sf	Up to 3 signs per building	15	Yes, external means only such as spotlight	Yes, up to 1.5 feet from a wall	
	P		9 sf	1 per street frontage	15	No	Yes, but not into a public way	
	PM2		See below under multi-tenant facilities sign types					
	11		2 sf per lf of building frontage up to a maximum of 100 sf	No limit up to permitted sign area	18	Yes	No	
	WMC		1 sf per lf of building frontage up to a maximum of 120 sf	No limit up to permitted sign area	22	Yes	Yes, but not into a public way or over the water	
	WME, WMI WMM		2 sf per lf of building frontage up to a maximum of 120 sf					
Marquee sign	Any district where the associated use is permitted		120 sf. The area of a marquee sign is permitted instead of, not in addition to wall-mounted or freestanding signage that would otherwise be permitted	1 per lot	15	Yes	Yes, up to the projection of the marquee	Theaters, museums and auditoriums with a marquee sign are permitted wall-mounted frames up to 24 sf

Sign Type	Zoning District	Number of Businesses per Lot	Maximum sign area	Number of signs allowed	Maximum height (feet)	Illumination permitted	Projection permitted	Other
Freestanding	B1, WMC		Pole signs: 12 sf, or ground signs: 20 sf	1 per lot	10	No	Yes but not into a public way or over the water	1. Freestanding signs are permitted only on lots with a minimum lot width of 100 feet or larger 2. Minimum setback from property lines: WMC 0 feet B1, 11, WME, WMI, WMM 5 feet Other districts 10 feet
	B2, B3, B3-CD BCE, 11, WME WMI, WMM	Lots with up to 2 businesses	Pole signs: 20 sf, or ground signs: 30 sf	1 per street frontage	Pole signs: 10 Ground signs: 12	Yes	Yes, but not into a public way or over the water	1. Freestanding signs are permitted only on lots with a minimum lot width of 100 feet or larger 2. Minimum setback from property lines: WMC 0 feet B1, 11, WME, WMI, WMM 5 feet Other districts 10 feet
	B2, B3, B3-CD BCE, 11, WME WMI, WMM	Lots with 3 or more businesses	Pole signs: 24 sf, or ground signs: 30 sf	1 per street frontage	Pole signs: 10 Ground signs: 12	Yes	Yes, but not into a public way or over the water	1. Freestanding signs are permitted only on lots with a minimum lot width of 100 feet or larger 2. Minimum setback from property lines: WMC 0 feet B1, 11, WME, WMI, WMM 5 feet Other districts 10 feet
	MX		30 sf	1 per street frontage	10	Yes	Yes, but not into a public way or over the water	Must be a ground sign, monument style
Multi-tenant facility signs								
Multi-tenant facility identification sign	B2, B3, B3-CD BCE, PM2, WMC, WME, WMI, WMM		64 sf	1 per street frontage	15	Yes	Yes, but not into a public way or over the water	1. In the P district and the waterfront districts these may be ground signs, monument style, or wall-mounted. 2. All other districts these signs must be ground signs, monument style. 2. Minimum setback from property lines: WMC 0 feet B1, 11, WME, WMI, WMM 10 feet Other districts 15 feet

Sign Type	Zoning District	Number of Businesses per Lot	Maximum sign area	Number of signs allowed	Maximum height (feet)	Illumination permitted	Projection permitted	Other
Multi-tenant facility identification sign	I1		100 sf	1 per street frontage	15	Yes	Yes, but not into a public way or over the water	1. In the P district and the waterfront districts these may be ground signs, monument style, or wall-mounted. 2. All other districts these signs must be ground signs, monument style. 2. Minimum setback from property lines: WMC 0 feet B1, I1, WME, WMI, WMM 10 feet Other districts 15 feet
Multi-tenant facility identification sign	MX, PM		30 sf	1 per street frontage	10	Yes, external means only such as spotlight	Yes, but not into a public way or over the water	1. In the P district and the waterfront districts these may be ground signs, monument style, or wall-mounted. 2. All other districts these signs must be ground signs, monument style. 2. Minimum setback from property lines: WMC 0 feet B1, I1, WME, WMI, WMM 10 feet Other districts 15 feet
Multi-tenant facility identification sign	P		15 sf	1 per street frontage	10	Yes, external means only such as spotlight	Yes, but not into a public way or over the water	1. In the P district and the waterfront districts these may be ground signs, monument style, or wall-mounted. 2. All other districts these signs must be ground signs, monument style. 2. Minimum setback from property lines: WMC 0 feet B1, I1, WME, WMI, WMM 10 feet Other districts 15 feet
Shopping center anchor tenant, wall-mounted	B2, PM2		0.5 sf per lf of anchor tenant facade	1 per street frontage	20	Yes	Yes, but not into a public way or over the water	Maximum sign board height 36" for anchors, 18" for other tenants. Maximum lettering height: 36" for anchors, 14" for other tenants
Tenant sign, wall-mounted	B2, B3, B3-CD BOE, PM2, I1, WMC, WME, WMI, WMM		1.5 sf of building frontage per tenant, up to 40 sf per tenant	1 per tenant, plus 1 additional for a corner tenant with windows in both facades	15	Yes	No	

Sign Type	Zoning District	Number of Businesses per Lot	Maximum sign area	Number of signs allowed	Maximum height (feet)	Illumination permitted	Projection permitted	Other
Tenant sign, wall-mounted	BR, MX, PM, P		Lesser of 1 sf per lf of entrance facade or 20 sf	1 per tenant, plus 1 additional for a corner tenant with windows in both facades	15	No	No	Maximum sign board height 36" for anchors, 18" for other tenants. Maximum lettering height: 36" for anchors, 14" for other tenants
Tenant sign, projecting	B2, B3, B3-CD BCE, PM2, WMC, WME WMI, WMM		6 sf	1 per tenant	6	Yes, external means only such as spotlight	Yes	This type of sign is permitted where tenant spaces are recessed under a canopied walkway
Business community identification sign	B1, P, PM		30 sf	1 at each entry point	6	Yes, external means only such as spotlight	Yes, but not into a public way	This type of sign is for communities comprising six or more businesses
Marine refueling facility signs on piers	WMC, WME, WMI, WMM		6 sf per face	1 per facility	10	Yes	No	

(Ord. O-10-07 Amended 1 (part), 2007; Ord. O-1-04 Revised (part), 2005)

Sidewalk Café Furniture Guidelines

Pursuant to Section 21.08.060 (E) (8) of the Sidewalk Café regulations adopted on November 13, 1995 (O-13-95), the Historic Preservation Commission (HPC) has revised and adopted the following furniture guidelines.

These guidelines are based on the more specific criteria for preserving our historic streetscapes as outlined in the Annapolis Historic District Design Manual, *Building in the Fourth Century*, published in 2007.

The Chief of Historic Preservation is authorized under Section 2.8 of the HPC Rules of Procedure to review through the administrative approval process applications that conform to the guidelines as established by the HPC for Sidewalk Cafés.

The HPC requires the following: Any lighting shall be restricted to table tops, and shall be very low intensity.

Planters

The HPC Design Manual provides types and materials (see HPC Guideline C.8 Landscape Planters and C.9 Landscape Plants). For sidewalk cafes, they shall be used for their historic purpose rather than as enclosures.

The HPC requires the following:

1. Planters shall be in scale with the space of the adjacent sidewalk and the adjacent building. Materials shall be compatible with the adjacent building façade;
2. Planters left on the sidewalk when the areas are not in use for dining shall be compatible with the architecture of the adjacent building;
3. Plant materials shall be compatible in scale with the adjacent building;
4. Hanging planters and window boxes shall be carefully placed so that they do not obscure or damage historic building features or create a potential hazard for pedestrians, café customers and staff;
5. Plant material must be well maintained.



FURNITURE

Lighting

The streets of the Historic District are well-lighted by reproductions of historically appropriate fixtures. Additional light is also provided through shop windows and illuminated signs.



Signs

Signs are regulated by Planning and Zoning and must be reviewed by HPC.

Furnishings

Furnishings are the most important element; therefore the HPC requires the following:

Selection of furnishings representative of those specified as “pre-approved” by the HPC. Furnishing catalogs are available for review at the Annapolis Historic Preservation Division office. Approved furnishings shall be durable and exhibit the following characteristics:

Suggested characteristics:

Portable, not permanently affixed to paving;

Compatible in style and scale with the adjacent building and outdoor space in which they are placed;

Simple in character and constructed of wood and painted metal; Contemporary materials may be substituted only upon verification that they qualify as an eco-friendly alternative.

Miscellaneous Provisions

The HPC will not approve the use of any “floor covering” on a public sidewalk.



STRUCTURAL ENCLOSURES

While O-13-95 addresses “furniture guidelines,” Title 21 of the City Code requires a Certificate of Approval by the HPC before a person may alter a structure in the historic district in a manner which affects the exterior appearance of the structure.

Enclosure of parts of the historic district’s narrow sidewalks with portable devices changes the historic character of the street and may alter traditional circulation patterns. Enclosures could also be misunderstood as extensions of historic buildings and could obscure historic buildings.

For these reasons, the HPC requires the following:

1. Sidewalk cafes shall be open to adjacent walks and shall not be enclosed or partially enclosed, by fences, planters, barriers, lattice, railings or ropes of any type;
2. There shall be no overhead structural enclosure, shading devices such as awnings, unless otherwise existing and approved for storefront use, or umbrellas;
3. Nothing shall be affixed to the building.

Revised and adopted at the Annapolis Historic Preservation Commission Hearing on April 28, 2011.



Shiplap House, 18 Pinkney Street. Its present appearance is a result of restoration efforts conducted in the 1960s and 1970s by Historic Annapolis Foundation. Today it serves as their headquarters. (Marion Warren Collection, Maryland State Archives MSA SC 1890-243)

Chapter 4

The Review Process

INTRODUCTION

The Design Guidelines contained in this manual and the Annapolis Historic District Zoning Ordinance (Chapter 21.56 of the City Code, see page 63) form the basis for the review of applications which are brought before the Historic Preservation Commission. The ordinance requires that:

“Before a person may undertake the construction, alteration, reconstruction, rehabilitation, restoration, moving, or demolition of a designated landmark, site, or structure, or a site or structure within a designated historic district, if any exterior change is made which would affect the historic, archaeological, architectural, or cultural significance of a site or structure within a designated district or a designated landmark, site, or structure any portion of which is visible or intended to be visible from a public way, the person, individual, firm, or corporation proposing to make the construction or change shall file an application for a certificate of approval with the Commission for permission to construct, alter, rehabilitate, restore, reconstruct, move, or demolish the landmark, site, or structure.”

Legal Basis for the Historic District

The Annapolis Historic District Ordinance has its legal basis in enabling legislation passed by the State of Maryland (Article 66B, Section 8.01 et seq. of the Annotated Code of Maryland) “to preserve a district in Annapolis which reflects elements of its cultural, social, economic, political and architectural history.” The purposes of the ordinance are 1) to stabilize and improve property values, 2) to preserve historically or

architecturally valuable buildings, 3) to “foster civic beauty,” 4) to strengthen the local economy, and 5) to “promote the use of the district for the education, pleasure and welfare of the citizens.”

The Historic District Ordinance states that the duty of the Commission is “to review any application to construct, alter, move, demolish or repair any structure within the historic district and to approve or reject each application, if any changes are visible or intended to be visible from an adjacent public way in the historic district.”

Approval of Proposed Changes

An application for a Certificate of Approval must be filed with the Commission at least twenty-five (25) days prior to the Commission’s regular monthly meeting. Once a complete application is filed, the Commission shall have forty-five (45) days within which to act upon it. If the Commission fails to act upon an application within the forty-five day period, the application shall be deemed approved, and the certificate shall be issued, unless the applicant and the Commission shall have agreed upon an extension of the period, or the application has been withdrawn.

Pre-Application Process

A voluntary and most useful part of the design review process is the early presentation by the applicant of design ideas in sketch fashion for Commission review. The pre-application process enables the applicant to present the basic concepts of the proposed change in sketch form without incurring the expense of a complete application. During the sketch review, the applicant

can present a single design proposal or present design options for discussion. A disapproved preliminary design saves the applicant the time and expense of developing a complete submission, and an approved preliminary design streamlines the final review process.

Application Submission Requirements

A complete application for a Certificate of Approval consists of an original (labeled "master package") and eleven copies of each of the following:

- 1 The completed application form.
- 2 Site plan.
- 3 Detailed drawings, including plans and elevations, of the proposed alterations or improvement.
- 4 For an existing structure, photographs of the structure showing the part or parts to be altered.
- 5 For a proposed new structure, photographs of the subject site and all buildings in the *immediate neighborhood*.

Drawings must be hard line (not freehand) drawings prepared to an appropriate scale. For most buildings, drawings should be presented at a scale of 1/4" equals one foot for plans and building elevations. For very large buildings, with Commission consent, elevation drawings may be prepared at a scale of 1/8" equals one foot. Storefronts and other detailed work should be presented at a minimum scale of 1/2" equals one foot.

The submitted drawings must show the details of construction, all materials must be labeled, and the finish treatment of all surfaces must be described. Sufficient specification notes should be included to allow an accurate understanding of the appearance of the new building or addition. For changes to existing structures, building parts should be clearly labeled as "new" or "existing."

Photographs should thoroughly show the subject site, adjacent properties, and details of any existing structures affected by the work. Photographs should be taken to show all views of the site possible from adjacent public rights of way. This should include rear elevations which can be seen from the street behind the lot, or views possible from higher elevations in the Historic District.

Original photographs must be mounted on 8-1/2" x 11" paper and labeled. Original photographs are to be included in the master set, while xerographic copies are acceptable for the other sets.

Copies of manufacturers' product literature showing products and items to be incorporated into the work should be included in the application package. Where submitted literature shows more than one product, the specific materials or items proposed must be indicated on the submission.

An application may be rejected and returned to the applicant if: 1) it does not comply with Planning and Zoning Department zoning requirements, or 2) the application does not include all the information required for Commission review.

Preliminary Comments

Written comments prepared by Historic Preservation Commission staff, the City Planning and Zoning Department, the Department of Neighborhood and Environment Programs, and Historic Annapolis Foundation are filed eleven (11) days before the hearing. Any citizen may also file written comments, as may an applicant who wishes to amend his or her application after review of written comments on file, provided the applicant's comments are filed prior to five (5) days before the hearing. An applicant may appear at a hearing with modified plans, in response to comments regarding the application. If minor, the Commission will accept the changes. If not, the modification will be reviewed on the following month's agenda.

Public Hearings

The Commission holds a public hearing on every application for a Certificate of Approval. At the hearing, the applicant and all other interested persons may testify. Every decision made becomes part of the public record. The City ordinance provides that, in the event an application is rejected, no new application for the same or similar work may be filed for one year. The Commission attempts to avoid outright rejection of an application and allows any application to be voluntarily withdrawn.

Protecting Significant Structures

For structures deemed to be of particular historical or architectural value, the Commission is strict in its judgment of applications. If an application is submitted for extensive reconstruction or exterior alterations or for its moving or demolition, the Commission shall work with the owner to formulate an economically feasible plan for the preservation of the structure. If no such plan can be formulated, the Commission shall have ninety (90) days to negotiate with the owner and other parties to find a means of preserving the building.

Appendix A

The Secretary of the Interior's Standards for Rehabilitation

The following Standards are to be applied to specific rehabilitation projects in a reasonable manner, taking into consideration economic and technical feasibility.

- 1** A property shall be used for its historic purpose or be placed in a new use that requires minimal change to the defining characteristics of the building and its site and environment.
- 2** The historic character of a property shall be retained and preserved. The removal of historic materials or alteration of features and spaces that characterize a property shall be avoided.
- 3** Each property shall be recognized as a physical record of its time, place, and use. Changes that create a false sense of historical development, such as adding conjectural features or architectural elements from other buildings, shall not be undertaken.
- 4** Most properties change over time; those changes that have acquired historic significance in their own right shall be retained and preserved.
- 5** Distinctive features, finishes, and construction techniques or examples of craftsmanship that characterize a historic property shall be preserved.
- 6** Deteriorated historic features shall be repaired rather than replaced. Where the severity of deterioration requires replacement of a distinctive feature, the new feature shall match the old in design, color, texture, and other visual qualities and, where possible, materials. Replacement of missing features shall be substantiated by documentary, physical, or pictorial evidence.
- 7** Chemical or physical treatments, such as sandblasting, that cause damage to historic materials shall not be used. The surface cleaning of structures, if appropriate, shall be undertaken using the gentlest means possible.
- 8** Significant archaeological resources affected by a project shall be protected and preserved. If such resources must be disturbed, mitigation measures shall be undertaken.
- 9** New additions, exterior alterations, or related new construction shall not destroy historic materials that characterize the property. The new work shall be differentiated from the old and shall be compatible with the massing, size, scale, and architectural features to protect the historic integrity of the property and its environment.
- 10** New additions and adjacent or related new construction shall be undertaken in such a manner that if removed in the future, the essential form and integrity of the historic property and its environment would be unimpaired.

Appendix B

Annapolis Architectural Glossary

architrave. 1) The lowest horizontal element of a classical entablature; see also orders. 2) The ornamental moldings (trim) around windows, doors and other wall openings.

asymmetrical. Not symmetrical.

baluster. A shaped, short vertical member, often circular in section, supporting a railing or capping.

balustrade. An assembly consisting of a railing or capping supported by a series of balusters.

bay. A regularly repeated main division of a building design. A building whose facade is five windows wide may be described as a five-bay building.

bay window. A window structure projecting beyond the main wall plane; if attached to the building above ground level, properly called an oriel.

blind. A louvered shutter that excludes vision and direct sunlight, but not indirect light and air, from a house.

bond. The setting pattern of bricks or stones, such as common bond, Flemish bond, etc.

bracket. A projecting support placed under an architectural overhang such as a cornice; often ornate.

bulk. The three-dimensional size or mass of a building.

capital. The top member (cap) of a column.

casement sash, casement window. A window sash which is side hinged; a window having casement sashes.

casings. The exposed architectural trim or lining around a wall opening.

clapboards. Narrow boards applied horizontally to an exterior wall, each of which overlaps the one below it to create a continuous skin over the wooden frame.

classical. 1) Decorative elements deriving directly or indirectly from the architectural vocabulary of ancient Greece and Rome; 2) architectural harmony based on the principles of ancient Greek and Roman architecture.

colonnade. A series of regularly spaced columns supporting an entablature.

column. A long vertical structural member that supports a load; in classical terms, a cylindrical support having a base, shaft and capital.

cornice. Strictly, the upper projecting part of an entablature; in carpenter/builder terminology, any projected moulding (“crown molding”) which crowns or finishes a horizontal fascia; the exterior assembly which closes the joint between the wall and roof of a building.

dependency. A subsidiary building adjoining a principal structure.

Doric. One of the 5 classical orders, column usually without a base and with a simple capital.

dormer. A roofed structure with a vertical window that projects from a pitched roof.

double-hung sash window. A window with two vertical sliding sash, each closing half of the window opening.

double pile. A floor plan that is two rooms deep.

eave. The lower part of a roof that projects beyond the wall.

- elevation.** The perpendicular view of a side of a building; an accurate drawing of one side of a building that represents its true dimensions in the plan perpendicular to the line of sight.
- ell.** A wing or addition extended at a right angle from the principal dimension of building, resulting in an “L” shaped plan.
- entablature.** The horizontal member carried by columns, composed of architrave (bottom), frieze and cornice (top); see also orders.
- facade.** The exterior front face of a building; usually the most ornate or articulated elevation.
- fanlight.** A half-circular or half-elliptical window; often placed over a door.
- fascia.** Any long, flat horizontal band or member.
- fenestration.** The arrangement and design of window and door openings in a building.
- flat arch.** An arch with a horizontal bottom, formed with wedge-shaped stones or bricks.
- Flemish bond.** A bond pattern in which each course consists of alternating stretcher and header bricks, and on alternating courses headers are centered on stretchers.
- French door.** A door with a top and bottom rail, stiles (sides) and glass panes throughout most of its length.
- frontispiece.** An ornamental portal or entrance bay around a main door.
- gable.** The vertical triangular shape of a building wall above the cornice height formed by two sloping roof planes.
- galleting.** A decorative pattern of pebbles or stone chips inserted in the mortar joints between stones.
- gambrel.** A roof with two pitches on each side of the ridge line.
- garret.** The space within the roof structure (attic).
- Georgian style.** Named after King George I, II, and III, the prevailing classical revival style of 18th century Great Britain and the North American colonies.
- header.** In brick masonry, a brick laid so that its end is exposed in the finished wall surface.
- header bond.** An unusual brick bond pattern in which the finished wall surface consists of all headers.
- hip.** The external angle at the intersection of two roof planes, a hip roof has roof planes that slope toward the center from all sides.
- hood.** A projecting cover placed over an opening to shelter it.
- hyphen.** A secondary building section connecting a dependency to the principal structure.
- in-kind.** Replacement of building components matching the original components in material, size, profile, texture, and color.
- jack arch.** See Flat arch.
- light.** A pane of glass installed in a window sash.
- lintel.** A horizontal structural member that spans an opening, for example a window lintel.
- Mansard.** A roof that is double pitched, the lower being much steeper, designed to allow a full story height within the attic space.
- mass.** Bulk or three-dimensional size of an object.
- massing.** The combination of several masses to create a building volume; organization of the shape of a building, as differentiated from wall treatment, fenestration, etc.
- modillions.** A small bracket used in a series to support the uppermost part of a classical cornice, usually found in the Corinthian or Composite Order.
- mullion.** A vertical member separating windows, doors or panels set in series; often used for structural purposes.
- muntin.** A slender member separating and encasing panes of glass in a window sash.
- order.** In classical architecture, a column with base (usually), shaft, capital, and entablature, embellished and proportioned according to one of the accepted styles—Tuscan, Doric, Ionic, Corinthian, and Composite.
- oriel.** A window structure projecting beyond the main wall plane attached to the building above ground level.
- Palladian.** Relating to the architectural designs of Andrea Palladio, Italian Renaissance architect.
- Palladian window.** A three part window consisting of a prominent center window unit, often arched, flanked by smaller windows.
- pane.** A flat sheet of glass cut to size for glazing use in a window; also called a light or a window light.
- parapet.** A low guarding wall at the edge of a roof or balcony; the portion of a fire wall or party wall above the roof level.
- parge.** A coating of cement-based mortar (stucco) applied over rough masonry work.
- pediment.** In classical architecture, the triangular gable end of a roof above a horizontal cornice.

pergola. A garden structure with an open wood-framed roof, often latticed.

picket fence. A fence formed by a series of vertical pales, posts or stakes and joined together by horizontal rails.

pilaster. A flat vertical element applied to the wall surface that simulates a classical column.

pitch, roof. The slope of a roof; usually expressed as a ratio of vertical rise to horizontal run (inches vertical in 12 inches horizontal).

plan. A two-dimensional view of a building, or horizontal section of it, seen from above; hence, a precise drawing showing the arrangement of design, including wall openings and dimensions.

porch. A structure attached to a building to shelter an entrance or to serve as a semi-enclosed space, usually roofed and generally open-sided.

portico. A porch or covered walkway with a roof supported by columns.

proportion. The relation of one dimension to another; usually described as a numerical ratio; in architecture, proportions determine the creation of visual order through coordination of shapes in a design.

quoin. A masonry (or simulated masonry) unit applied to the corner of a building; often slightly projecting.

rhythm. In architecture, the repeated pattern of building elements such as doors and windows.

ridge, ridge line. The horizontal line formed by the juncture of two sloping roof planes

sash. The movable framework holding the glass in a window.

scale. A measure of the relative or apparent size of a building or building component in relation to a known unit of measure or a familiar size for such a component. A building is of human scale when the size of architectural components relates to the size of an adult human body.

segmental arch. An arch in which the arched portion is less than a semi-circular.

shed roof. A single-pitched roof over a small room; often attached to a main structure.

shutter. An external movable screen or door used to cover a wall opening, especially a window; originally for security purposes; often confused with louvered blinds.

sidelight. A framed area of fixed glass alongside a door or window opening.

sill. The horizontal lower member of a window or other frame.

single pile. A floor plan that is one room deep.

site plan. An accurate scaled drawing of a site (lot) as if seen from above, describing the property boundary and orientation, the location of buildings, driveways, walks and other constructed site improvements, the retained vegetation and new plantings and finished grade contours.

skylight. A glazed opening in a roof plane that admits light.

stoop. An uncovered platform and steps at an entrance.

streetscape. A setting or expanse consisting of the street, landscaping, and buildings along a street, as seen by the eye in one view.

stretcher. A brick laid with the long side visible in the finished work.

string course. A horizontal course of masonry or wood trim which projects from a wall.

symmetrical. A similarity of form or arrangement on either side of a dividing line.

transom. A horizontal bar of wood separating a door from a transom window above it.

vernacular. A mode of building based on regional forms and materials.

water table. A horizontal course of masonry or wood trim separating the foundation walls from the exterior walls above.

(Glossary definitions are in part based on *Historic Architecture Sourcebook* by Cyril M. Harris, ed., New York: McGraw-Hill Book Company, 1977).

Appendix C

City of Annapolis Historic District Zoning Ordinance

Chapter 21.56 HISTORIC DISTRICT

Article I Approval of Exterior Changes

- 21.56.010 Authority and purpose.
 - 21.56.020 Definitions.
 - 21.56.030 Boundaries.
 - 21.56.035 Sales of historic real property.
 - 21.56.040 Certificate of approval.
 - 21.56.050 Certificate of approval--Demolition.
 - 21.56.060 Application review.
 - 21.56.070 Certificate of approval--Commission decision.
 - 21.56.080 Certificate of approval--Expiration.
 - 21.56.090 Maintenance, repair, and demolition by neglect.
 - 21.56.100 Undergrounding of utilities.
 - 21.56.110 Appeals.
 - 21.56.120 Historic preservation violations.
 - 21.56.130 Severability.
 - 21.56.140 Statutory authority.
- #### Article II Height and Bulk Limits
- 21.56.150 Purpose.
 - 21.56.160 Applicability.
 - 21.56.170 Height measurement.
 - 21.56.180 Special height limit districts.
 - 21.56.190 Front setback for replacement buildings.
 - 21.56.200 Side yards.
 - 21.56.210 Width of buildings.
 - 21.56.220 Existing buildings.

Article I Approval of Exterior Changes

21.56.010 Authority and purpose.

A. The Mayor and City Council of the City of Annapolis, Maryland, derives authority for this chapter by virtue of its conformance with provisions of the State of Maryland Enabling Act for Historic Area Zoning, Article 66B, Zoning and Planning, Section 8.01--8.17, Annotated Code of Maryland, as amended.

B. The preservation of sites, structures, and districts of historical, cultural, archaeological, or architectural significance together with their appurtenances and environmental settings is a public purpose.

C. It is the further purpose of this article to preserve and enhance the quality of life and to safeguard the historical and cultural heritage of Annapolis by preserving sites, structures, or districts which reflect the elements of the City's cultural, social, economic, political, archaeological, or architectural history; to strengthen the local economy; to stabilize and improve property values in and around such historic areas; to foster civic beauty, and to preserve and promote the preservation and appreciation of historic sites, structures and districts for the education and welfare of the citizens of the City. (Ord. O-1-04 Revised (part), 2005)

21.56.020 Definitions.

For the purposes of this chapter, the following words and phrases shall have the meanings respectively ascribed to them:

"Alteration" shall mean any exterior changes that would affect the historic, cultural or architectural significance of a designated site or structure, any portion of which is visible or intended to be visible from a public way including, but not limited to, construction, reconstruction, moving or demolition.

"Appurtenances and environmental settings" shall mean all that space of grounds and structures thereon which surrounds a designated site or structure and to which it related physically and/or visually.

Appurtenances and environmental settings shall include, but not be limited to, walkways and driveways (whether paved or not), trees, landscape elements, waterways, open space, setbacks, parks, public spaces, and rocks.

“Certificate of approval” shall mean a certificate issued by the Historic Preservation Commission indicating its approval of plans for construction, alteration, reconstruction, rehabilitation, restoration, moving, or demolition of an individually designated landmark, site, or structure or of a site or structure within a designated historic district.

“Cultural” shall mean that which relates to the artistic, historic, intellectual, educational, archaeological, or architectural aspects of the City of Annapolis.

“Demolition” shall mean any act which destroys, in whole or in part, an individually designated landmark, site, or structure, or a site or structure within a designated historic district not including appurtenances and environmental settings.

“Demolition by neglect” shall mean any willful neglect in the maintenance or repair of an individually designated landmark, site, or structure, or a site or structure within a designated historic district, not including any appurtenances and environmental settings, that does not result from an owner’s financial inability to maintain and repair such landmark, site, or structure, and which results in any of the following conditions:

1. The deterioration of the foundations, exterior walls, roofs, chimneys, doors, or windows, so as to create or permit a hazardous or unsafe condition to exist; or
2. The deterioration of the foundations, exterior walls, roofs, chimneys, doors, or windows, the lack of adequate waterproofing, or the deterioration of interior features, which will or could result in permanent damage, injury, or loss of or loss to foundations, exterior walls, roofs, chimneys, doors or windows.

“Historic district” shall mean a significant concentration, linkage, or continuity of sites or structures united historically, architecturally, archaeologically, or culturally, by plan or physical development. An historic district shall include all property within its boundaries as defined and designated by the City Council.

“Exterior features” shall mean the architectural style, design, and general arrangement of the exterior of an historic structure, including the nature and texture of building material, and the type and style of all windows, doors, light fixtures, signs or similar items found on or related to the exterior of an historic structure.

“Landmark” shall mean any site or structure, designated by the City Council, that is of exceptional historic, cultural, archaeological, or architectural significance.

“Maintenance” shall mean work that does not alter the exterior fabric or features of a landmark, site or structure and has no material effect on the historical,

archaeological, or architectural or cultural significance of the historical landmark, site or structure.

“New construction” shall mean construction which is characterized by the introduction of new elements, sites, buildings, or structures or additions to existing buildings and structures in historic districts.

“Preservation” shall mean actions taken to prevent or keep a structure from decay or degradation.

“Reconstruction” shall mean the process of reproducing, by new construction, the exact form and detail of a vanished structure, or part thereof, as it appeared at a specific period of time.

“Rehabilitation” shall mean the act or process of returning a property or building to usable condition through repair, alteration, and/or preservation of its features which are significant to its historical, architectural, and cultural values.

“Repair” shall mean the process of rehabilitation which warrants additional work beyond simple maintenance, repair, includes patching, piecing in, splicing, consolidating or otherwise, reinforcing materials according to recognized preservation methods.

“Restoration” shall mean the process of accurately recovering the form and details of a property as it appeared at a specific period of time by means of removal of later work and the replacement of work missing from that period.

“Site” shall mean the location of an event of historic significance or the location of a structure whether standing or ruined, which possesses historic, architectural, archaeological, or cultural significance.

“Structure” shall mean a combination of material to form a construction that is stable including, but not limited to, buildings, stadiums, reviewing stands, platforms, stagings, observation towers, radio towers, water tanks and towers, trestles, bridges, piers, paving, bulkheads, wharves, sheds, coal bins, shelters, fences, and display signs visible or intended to be visible from a public way. The term “structure” shall be construed as if followed by the words, “or part thereof.” (Ord. O-1-04 Revised (part), 2005)

21.56.030 Boundaries.

A. The boundaries of the Annapolis historic district are established as follows:

Beginning for the same at the intersection of the centerline of Southgate Avenue with the tidewaters of Spa Creek; thence leaving the beginning point and running with the tidewaters of Spa Creek westerly one hundred fifty feet, more or less, to intersect a line drawn parallel to and distant southwesterly one hundred fifty feet, as measured at right angles from the centerline of Southgate Avenue; thence leaving the tidewaters of Spa Creek and running northwesterly with the line parallel to Southgate Avenue to intersect the centerline of Franklin Street; thence leaving Franklin Street, continuing parallel to Southgate Avenue one hundred feet, more or less, to intersect a line drawn parallel to

and distant northwesterly one hundred feet as measured at right angles from the centerline of Franklin Street; thence leaving the line parallel to Southgate Avenue and running with the line parallel to Franklin Street northeasterly to intersect the centerline of Shaw Street from the point of intersection running northwesterly following the centerline of Shaw Street northwesterly to a point one hundred fifty-five feet distant as measured from the intersection of the centerline of Shaw Street and the centerline of Lafayette Avenue; thence leaving the point of intersection and running in a southwesterly direction for eighty feet following the east property line of Lot 45 as shown on a plat of City Gate, section 1, recorded among the land records of Anne Arundel County in plat book 77, page 26; thence leaving the line and running in a northwesterly direction following the rear property lines of Lots 45a, 44, 43, 42 and 41 as shown on the plat to a point intersecting the centerline of Lafayette Avenue; thence following the centerline of Lafayette Avenue in a northerly direction for a distance of two hundred feet; thence leaving the centerline of Lafayette Avenue and running in an easterly direction following the southerly property line of Parcel 546 as shown on Tax Map 30 of Annapolis, as prepared by the Maryland Department of Assessments and Taxation, to a point intersecting the centerline of Water Street; thence following the centerline of Water Street in a northerly direction to a point intersecting with the centerline of Larkin Street; thence following the centerline of Larkin Street in an easterly direction to a point intersecting the centerline of City Gate Lane; thence following the centerline of City Gate Lane in a northerly direction to a point intersecting the centerline of West Street; thence running with the centerline of West Street easterly one hundred feet to intersect the centerline of Calvert Street; thence running with the centerline of Calvert Street northerly to intersect the centerline of Northwest Street; thence westerly with the centerline of Northwest Street to a point distant one hundred feet from the centerline of the eastbound lane of the Roscoe Rowe Boulevard; thence parallel with the eastbound lane of Roscoe Rowe Boulevard to the shoreline of College Creek; thence leaving the parallel to Roscoe Rowe Boulevard and running with the shoreline in a general northerly and northeasterly direction to intersect the present property line of the United States Naval Academy; thence leaving the shoreline of College Creek and running with the present divisional lines between the United States Naval Academy and the City of Annapolis to the intersection of the northeast side of Prince George Street with the shoreline of Spa Creek; thence leaving the United States Naval Academy property and the present property line and running with the shoreline generally in a westerly direction to the place of beginning. Excepting all that property known as St. Anne's cemetery.

Saving and excepting all that property known as Southgate Harbor shown on a plat filed among the plat records of Anne Arundel County, Maryland, in plat book

41, folios 3 and 4, which is the same property conveyed by E. Nyce Feldmeyer, unmarried, to C. Edward Hartman, II and Patricia M. Hartman, his wife, by deed dated April 26, 1956, and recorded among the land records of Anne Arundel County in liber G.T.C. 1559, folio 161.

B. The City Council may designate boundaries for landmarks, sites, structures, or districts of historic, cultural, archaeological, or architectural significance.

C. Recommendations for designation of landmarks, sites, structures and districts shall be submitted to the City Council for consideration. The Historic Preservation Commission may, after making full and proper study, recommend any area within the limits of the City for designation as a landmark, site, structure, or district of historic, cultural, archaeological, or architectural significance. The Commission shall recommend boundaries for the landmarks, sites, structures, and districts.

D. The City Council or the Commission may petition the Maryland Historical Trust to make an analysis of and recommendation concerning the preservation of landmarks, sites, structures, or districts of historic, archaeological, architectural, or cultural significance within the City. Such report may include proposed boundaries of sites, structures, or districts, as well as recommendations for the identification and designation of particular sites, structures, or districts to be preserved. (Ord. O-1-04 Revised (part), 2005)

21.56.035 Sales of historic real property.

A contract for the sale of real property located in the Historic District as defined by Section 21.56.030 shall include a highlighted statement that the subject property is in the District and that the buyer should visit the website of the Historic Preservation Commission to learn about the various requirements that apply to properties located in the District. The buyer shall be request to initial this statement indicating that the buyer is aware that the property is in the District. If this highlighted statement is not included in the sales contract, then the contract is voidable up until the execution of the deed. (Ord. O-19-06 Amended § 1, 2007)

21.56.040 Certificate of approval.

A. When Required. Before a person may undertake the construction, alteration, reconstruction, rehabilitation, restoration, moving, or demolition of a designated landmark, site, or structure, or a site or structure within a designated historic district, if any exterior change is made which would affect the historic, archaeological, architectural, or cultural significance of a site or structure within a designated district or a designated landmark, site, or structure any portion of which is visible or intended to be visible from a public way, the person, individual, firm, or corporation proposing to make the construction or change shall file an application for a certificate of approval with the Commission for permission to construct, alter, rehabilitate, restore,

reconstruct, move, or demolish the landmark, site, or structure.

B. Application. An application for a certificate of approval shall be filed with the clerk to the Historic Preservation Commission. Each application shall include maps, plans and other necessary data and documents required by the rules of the Commission and shall be advertised in the manner provided in the rules. Additionally, the property shall be posted in accordance with the rules and regulations adopted by the Commission. Application fees shall be determined by the Department of Planning and Zoning.

C. Referral to and Consideration by the Commission. Every application shall be referred to and considered by the Commission and accepted, accepted with modifications, or rejected by the Commission. An application which is identical to a rejected application may not be resubmitted within a period of one year after the rejection. No certificate of approval shall be granted until the Commission has acted thereon as hereinafter provided. (Ord. O-1-04 Revised (part), 2005)

21.56.050 Certificate of approval--Demolition.

An application for demolition of a structure shall include plans for a replacement structure. Approval for the demolition of a structure may be conditioned upon the construction of an acceptable replacement structure, or landscape or park plan. A bond or other financial guaranty in the amount of the cost of the replacement structure may be required in order to assure the construction of the replacement structure, or park, or landscape plan. (Ord. O-1-04 Revised (part), 2005)

21.56.060 Application review.

A. In reviewing applications, the Commission shall give consideration to the historic, cultural, archaeological, or architectural significance of the landmark, site, or structure and its relationship to the historic, cultural, archaeological, or architectural significance of the surrounding area; the relationship of the exterior architectural features of a landmark, site, or structure to the remainder of the landmark, site, or structure and to the surrounding area; the general compatibility of proposed exterior design, scale, proportion, arrangement, texture, and materials to the landmark, site, or structure and to the surrounding area; and any other factors including aesthetic factors which the Commission deems to be pertinent.

B. The Commission shall consider only exterior features of a landmark, site, or structure and shall not consider any interior arrangements.

C. The Commission shall not disapprove an application except with respect to the several factors specified in subsection A of this section.

D. The Commission shall be strict in its judgment of plans for landmarks, sites or structures determined by research to be of historic, cultural, archaeological, or architectural significance. The Commission shall be lenient in its judgement of plans for landmarks, sites

or structures of little historic, cultural, archaeological, or architectural significance, or of plans involving new construction, unless in the Commission's judgement such plans would seriously impair the historic, cultural, archaeological, or architectural significance of surrounding landmarks, sites or structures. The Commission is not required to limit construction, reconstruction, or alteration to any one period of architectural style.

E. Special Considerations.

1. If an application is submitted for construction, reconstruction, or alteration affecting a landmark, site or the exterior of a structure or for the moving or demolition of a structure, the preservation of which the Commission considers to be of unusual importance to the City, State, or Nation, the Commission shall attempt to formulate an economically feasible plan with the owner(s) of the site or structure for the preservation of the landmark, site or structure.

2. In the circumstances described above in subsection (E)(1) of this section, unless the Commission is satisfied that the proposed construction, alteration, or reconstruction will not materially impair the historic, cultural, archaeological, or architectural significance of the landmark, site or structure, the Commission shall reject the application, filing a copy of its rejection with the Department of Public Works.

3. If an application is submitted for construction, reconstruction, or alteration, or for the moving or demolition of a landmark, site or structure that the Commission considers to be of unusual importance and no economically feasible plan can be formulated, the Commission shall have ninety days, from the time it concludes that no economically feasible plan can be formulated, to negotiate with the owner(s) and other parties in an effort to find a means of preserving the landmark, site or structure. At the end of such ninety day period, if no means of preserving the landmark, site or structure has been found, the Commission shall either approve, approve with modifications, or reject the application.

4. In the case of a landmark, site or structure considered to be valuable for its historic, cultural, archaeological, or architectural significance, the Commission may approve the proposed construction, reconstruction, alteration, moving, or demolition despite the provisions of subsection (E)(2) of this section, if the Commission finds that:

a. The landmark, site or structure is a deterrent to a major improvement program which will be of substantial benefit to the City;

b. Retention of the landmark, site or structure would cause undue financial hardship to the owner; or

c. Retention of the landmark, site or structure would not be in the interests of a majority of persons in the City.

(Ord. O-1-04 Revised (part), 2005)

21.56.070 Certificate of approval--Commission decision.

A. The Commission shall file with the Department of Public Works a certificate of approval certifying its approval or modification of each application and plans submitted to it for review. If an application is rejected, the Commission shall notify the Department of Public Works.

B. Work shall not be commenced on any project until such a certificate of approval has been filed, and the Department of Public Works shall not issue a building permit for such change or construction unless it has received such a certificate of approval.

C. Failure of the Commission to act upon a completed application within forty-five days from the date the completed application was filed shall be deemed to constitute automatic approval of the proposed changes unless an extension of the forty-five day period is mutually agreed upon by the applicant and the Commission or the application has been withdrawn and except as provided by Section 21.56.060(E)(3) of this section. (Ord. O-1-04 Revised (part), 2005)

21.56.080 Certificate of approval--Expiration.

A certificate of approval of the Commission shall expire automatically, unless extended by the Commission, if:

A. In the case of an application for the demolition, moving or alteration of a structure, the work has not commenced within six months and been completed within one year from the date of issuance of the certificate of approval;

B. In the case of an application for the construction of a new structure, the work has not commenced within one year from the date of issuance of the certificate of approval and been completed within three years; or

C. For the purposes of this section, application for extension of approval shall be treated and considered as a new application before the Commission. (Ord. O-1-04 Revised (part), 2005)

21.56.090 Maintenance, repair, and demolition by neglect.

A. Nothing in this article shall be taken or construed to prevent maintenance that does not alter the exterior fabric or features of a designated landmark, site, or structure, or landscape elements, and which will have no material effect on the historic, cultural, archaeological, or architectural significance of a designated landmark, site, structure, or district.

B. In the event of demolition by neglect, the Commission may request that the Mayor's office notify, in writing, the property owner(s) of record, any person(s) having a right, title, or interest therein, and the occupant(s) or other person(s) responsible for the maintenance of the property, of the deterioration. The notice shall specify the minimum items of repair or maintenance necessary to correct the deterioration or prevent further deterioration.

C. Prior to the issuance of a written notice, the Commission may request that the City establish a record of demolition by neglect. Such record may include dated

materials such as photographs and written reports of the condition of the property so as to record or measure the deterioration.

D. The notice shall provide that corrective action shall commence within thirty days of the receipt of said notice and be completed within a reasonable time thereafter. The notice shall state that the owner(s) of record of the property, or any person(s) of record with any right, title, or interest therein, may, within ten days after the receipt of the notice, request a hearing on the necessity of the items and conditions contained in the notice. In the event a public hearing is requested, it shall be held by the Commission upon thirty days' written notice being mailed to all persons of record with any right, title, or interest in the property and to all citizens and organizations which the Commission determines may have an interest in the proceedings.

E. If, after the public hearing, the Commission determines that the corrective actions remain necessary, the Commission may request that the Mayor issue final notice to be mailed to the owner(s) of record and all parties of record with any right, title, or interest in the property, advising them of the items of repair and maintenance necessary to correct the deterioration or prevent further deterioration. The owner shall institute corrective action to comply with the final notice within thirty days of receipt of the final notice.

F. Upon failure, neglect, or refusal of the property owner(s) or other responsible person(s), duly notified, to take the corrective action specified in the final notice within the time required, the Commission may request that the Mayor's office institute any of the remedies and penalties provided by law for such violations. (Ord. O-1-04 Revised (part), 2005)

21.56.100 Undergrounding of utilities.

A. The City may require that utility companies relocate underground existing overhead lines and facilities within a defined part of the district or the entire district, and require that the connection thereto be placed underground, if necessary by private owners then receiving service from the overhead lines and facilities. The City shall provide:

1. That the estimated cost to property owners, for work to be performed on private property, be determined and made available to affected property owners;
2. That financing of these costs to private owners be provided including any charges for the amortization of the bonds issued to initially cover such private costs. The City may enter into agreement with individual property owners whereupon it will advance funds to cover the property owner's costs involved in the conversion of the overhead lines and facilities and may appropriate funds, levy taxes or borrow funds to pay and advance the costs of such conversion. The City may also impose a benefit assessment against the property in the district for which the conversion is made in order to recapture such expended costs and make appropriate provisions for the

collection thereof; and

3. For any other provisions reasonably related to the objectives of placing underground overhead lines and facilities, and the administration of such projects.

B. Notwithstanding any other provision in this section, the Public Service Commission shall prescribe the amount of the monthly surcharge required to support the net capital costs and determine which customers of the applicable utility are subject to the surcharge, or the Commission shall include the related net capital costs in the rate base, or shall adopt any other method to appropriately apportion the said costs. However, in no event shall the utility be required to pay more than fifty percent of the net capital costs. The City is authorized to make appropriations for such relocation projects from any appropriate Federal, State and local funds it receives for this purpose. (Ord. O-1-04 Revised (part), 2005)

21.56.110 Appeals.

Any person or persons, firm or corporation aggrieved by a decision of the Commission has a right of appeal to the Anne Arundel County Circuit Court and a further appeal to the Court of Special Appeals of Maryland. Appeal requests must be filed within thirty days from the date of the Commission decision. (Ord. O-1-04 Revised (part), 2005)

21.56.120 Historic preservation violations.

A. Any person(s) who willfully performs or allows to be performed any work without first obtaining a certificate of approval, fails to comply with any final notice issued pursuant to this article, or disregards a decision of the Commission will be in violation of the provisions of this article. A violation of the article shall be deemed a municipal infraction as stated in the City Code. Each and every day that the violation continues shall be deemed a separate offense. Violators may be assessed a fine as established by the City Council for each day that the violation continues.

B. In addition to other remedies and penalties, where there is a violation of this article, the Planning and Zoning Director, through the City Attorney, shall institute appropriate action to prevent, enjoin, abate or remove the violation. (Ord. O-1-04 Revised (part), 2005)

21.56.130 Severability.

If any provisions of this article or the application thereof to any person(s) or circumstances are held invalid for any reason, such invalidity shall not affect the other provisions of any other application of this article which can be given effect without the invalid provisions or application, and to this end, all the provisions of this article are declared to be severable. (Ord. O-1-04 Revised (part), 2005)

21.56.140 Statutory authority.

The authorities for this law are Section 4.01 et seq. and Section 8.01 et seq. of Article 66B of the Annotated Code of Maryland. Nothing in this law shall be construed

to limit the authority of the Historic Preservation Commission of the City to review proposals with respect to height and bulk. (Ord. O-1-04 Revised (part), 2005)

Article II Height and Bulk Limits

21.56.150 Purpose.

The purpose of this article is to provide for light and the circulation of air, to prevent the congestion of population, to implement the purpose set forth in Section 21.56.010 of this chapter, and to better preserve the existing historical and architectural character of the historic district by limiting the height and bulk of buildings in the historic district. (Ord. O-1-04 Revised (part), 2005)

21.56.160 Applicability.

The special height and bulk limits apply only to land within the historic district and are intended to be supplementary and in addition to the more general factors of compatibility set forth in Section 21.56.100 of Article I of this chapter. (Ord. O-1-04 Revised (part), 2005)

21.56.170 Height measurement.

The height of buildings shall be determined in the following manner:

A. All measurements shall be taken from the center of the building at the front setback line; provided, however, that if the building is greater than forty-four feet wide, the massing shall conform to Section 21.56.210. In buildings greater than forty-four feet in width, the building height measurement shall be taken at the highest point of each building element at the front setback line.

B. Antennas and mechanical equipment up to thirty inches high shall not be counted in computing height, and penthouses, other structures and mechanical equipment thirty inches in height shall be used in computing height; chimneys are excluded.

C. For the purpose of achieving a permanent height limit, the height of a building shall not be allowed to increase because of an increase in the elevation of the front setback line occurring after the effective date of this Zoning Code.

D. Height Measurement in Special Height Limit Districts.

1. Two limits are established for each height district:

a. The height of a building at its highest point.
b. The height of a cornice or lower roofline of the building at the front setback line.

2. The height of a building behind the front setback line may be increased provided it does not exceed a plane projected at an angle of forty-five degrees upward from the maximum allowable cornice or lower roofline height at the front setback line. The plane may contain roof dormers provided the sum of their widths does not exceed fifty percent of the street front linear dimensions of the building.

3. For gambrel and gable roofs with ridge lines

perpendicular to the street, the height of a cornice or lower roofline will be measured at the side wall at the front setback line, and the height of the building at its highest point will be measured at the ridge line.

Illustration for height measurement.

Height District per 21.56.180	Height of Cornice or Lower Roofline at Front Setback	Maximum Building Height
1	22'	32'
2	28'	38'
3	35'	45'

(Ord. O-1-04 Revised (part), 2005)

21.56.180 Special height limit districts.

A. Establishment. Three special height limit districts are established: district 1, district 2 and district 3.

B. Location and Boundaries. The location and boundaries of the special height limit districts are as set forth on the map entitled "Historic District Special Height and Bulk Limits, Revised, May, 1983," certified copies of which are to be maintained by the Department of Planning and Zoning, which constitutes a part of the "City of Annapolis Zoning District Map," established by Section 21.06.020.

C. Applicability. The special height and bulk limits in these districts shall govern over any other height and bulk limits established in other provisions of this Zoning Code.

D. Regulations.

1. No building in the special height limit district 1 may exceed a total height of thirty-two feet and a height of twenty-two feet at the cornice or lower roofline measured at the front setback line.

2. No building in the special height limit district 2 may exceed a total height of thirty-eight feet and a height of twenty-eight feet at the cornice or lower roofline measured at the front setback line.

3. No building in the special height limit district 3 may exceed a total height of forty-five feet and height of thirty-five feet at the cornice or lower roofline measured at the front setback line. (Ord. O-1-04 Revised (part), 2005)

21.56.190 Front setback for replacement buildings.

Within the limits of the historic district, front setback provisions for the C1, C1A, C2, C2A and C2P districts shall be modified to provide that where a new building is constructed which takes the place of an existing building, the new building may be constructed with the same front setback as existed for the building it replaces; otherwise, the new building shall be subject to the provisions of the bulk regulations for those districts. (Ord. O-1-04 Revised (part), 2005)

21.56.200 Side yards.

Within the limits of the historic district the interior side yard requirement specified in the bulk regulations table

for the C-1 district shall be modified to require:

A. Existing Yards. Existing side yards shall be maintained; provided, that they are not required to be greater than five feet.

B. New Construction.

1. Where a new building or building addition replaces a building or part of a building that had a side yard, the side yard shall be maintained; provided, that it is not required to be greater than five feet.

2. Where a new building replaces a building which did not have side yard, then a side yard is not required.

3. In all other cases of new building, a side yard of five feet is required. (Ord. O-1-04 Revised (part), 2005)

21.56.210 Width of buildings.

A. The width of new buildings is governed by the width of their individual building elements (as defined in subsection C of this section) which should be compatible with the massing of structures in the surrounding neighborhood and with the historic district to maintain the historic and architectural character of the historic district.

B. The width of individual building elements may not exceed twice the height of the lower roofline of the building as measured at the front setback line.

C. "Building elements" means an unbroken roof ridge line, cornice or lower roofline, or wall. A building element will be considered broken if it is significantly offset from another building element, or separated from another building element by a projection or recess creating a substantial and distinct shadow line. (Ord. O-1-04 Revised (part), 2005)

21.56.220 Existing buildings.

No building lawfully existing on the effective date of this Zoning Code shall be considered to be nonconforming because of a failure to comply with the provisions of this article, and nothing in this article prevents the restoration of a damaged or destroyed building, subject, however, to the approval of the Historic Preservation Commission and Section 21.68.020. (Ord. O-1-04 Revised (part), 2005)

Appendix D

Selected Bibliography

MARYLAND HISTORY

- Carr, Lois G., Morgan, Philip D., and Russo, Jean B., eds. *Colonial Chesapeake Society*. Chapel Hill and London: University of North Carolina Press for the Institute of Early American History and Culture, 1988.
- Land, Aubrey C. *Colonial Maryland, A History*. Millwood, New York: KTO Press, 1981.
- Middleton, Arthur Pierce. *Tobacco Coast: A Maritime History of the Chesapeake Bay in the Colonial Era*. 1953. Reprint, Baltimore: The Johns Hopkins University Press, 1984.

ANNAPOLIS HISTORY

- Middleton, Arthur Pierce and Iseley, N. Jane. *Annapolis on the Chesapeake*. Greensboro, NC: Legacy Publications for Historic Annapolis, Inc., 1988.
- Riley, Elihu Samuel. *The Ancient City: A History of Annapolis in Maryland, 1649-1887*. Annapolis, MD: Record Printing Office, 1887; reprinted Annapolis: Anne Arundel County and Annapolis Bicentennial Committee, 1977.
- Warren, Mame. *Then Again. . . Annapolis, 1900-1965*. Annapolis, MD: Time Exposures, Limited, 1990.
- Warren, Marion E. and Warren, Mary Elizabeth. "The Train's Done Been and Gone," *An Annapolis Portrait, 1859-1910*. Annapolis, MD: M.E. Warren, 1976.

AMERICAN ARCHITECTURE

- Blumenson, John J. G. *Identifying American Architecture: A Pictorial Guide to Styles and Terms, 1600-1945*. Nashville, TN: American Association of State and Local History, 1982.
- Gowans, Alan. *Images of American Living*. New York: Harper & Row, 1976.
- Harris, Cyril M. *Architecture Sourcebook*. New York: McGraw-Hill Book Company, 1977.
- Morrison, Hugh. *Early American Architecture from the First Colonial Settlements to the National Period*. New York: Oxford University Press, 1952.
- Pierson, William H., Jr. *American Buildings and Their Architects, The Colonial and Neoclassical Styles*. Garden City, NY: Anchor Books, 1970.
- Rifkind, Carol. *A Field Guide to American Architecture*. New York and London: New American Library, Inc., 1980.
- Whiffen, Marcus. *American Architecture Since 1780: A Guide to the Styles*. Cambridge, MA and London: The MIT Press, 1969; reprinted 1981.
- Whiffen, Marcus and Kolpers, Frederick. *American Architecture, 1607-1976*. Cambridge, MA: The MIT Press, 1981.

ANNAPOLIS ARCHITECTURE AND TOWN PLAN

- Anderson, Elizabeth B. *Annapolis: A Walk Through History*. Centreville, MD: Tidewater Publisher, 1984.
- Coffin, Lewis A. and Holder, Arthur C. *Brick Architecture of the Colonial Period in Maryland and Virginia*. New York: Architectural Book Publishing Co., 1919; reprinted New York: Dover Publications, Inc., 1970.
- Historic Annapolis, Inc. *A Guide to Domestic and Commercial Architectural Styles in Annapolis*. Annapolis, MD: Historic Annapolis, Inc., 1975.
- Kearns, Richard. "The Annapolis Cityscape," in *The Magazine Antiques* CXI: 1 (January 1977), pp. 194-200.
- Miller, Marcia M. and Ridout V, Orlando. *Architecture in Annapolis, A Field Guide*. Crownsville, MD: The Vernacular Architecture Forum and The Maryland Historical Trust Press, 1998. Copyright 2001, Maryland Historical Trust.

Reps, John. *Tidewater Towns*. Williamsburg, VA: Colonial Williamsburg Foundation, 1972.

Tatum, George B. "Great Houses from the Golden Age of Annapolis," in *The Magazine Antiques* CXI: 1 (January 1977), pp. 174-186.

Trostel, Michael L. "The 'Annapolis Plan' in Maryland," in *Building by the Book*, Mario di Valmoroso, ed. Charlottesville, VA: University Press of Virginia for the Center for Palladian Studies in America, 1986, pp. 1-34.

Ware, Donna M. *Anne Arundel's Legacy: The Historic Properties of Anne Arundel County*. Annapolis: Anne Arundel County, 1990.

Wright, Russell J. "The Town Plan of Annapolis," in *The Magazine Antiques* CXI: 1 (January 1977), pp.148-151.

BUILDING REHABILITATION, RESTORATION, AND CONSERVATION

Bowyer, Jack, ed. *Handbook of Building Crafts in Conservation*. New York and London: Van Nostrand Reinhold Co., 1981.

Kitchen, Judith I. *Caring for Your Old House: A Guide for Owners and Residents*. Washington, DC: The Preservation Press, 1991.

London, Mark. *Masonry: How to Care for Old and Historic Brick and Stone*. Washington, DC: The Preservation Press, 1988.

McKee, Harley J. *Introduction to Early American Masonry; Stone, Brick, Mortar and Plaster*. Washington, DC: National Trust for Historic Preservation and Columbia University, 1973.

Melville, Ian A. and Gordon, Ian A. *The Repair and Maintenance of Houses*. London: The Estates Gazette Ltd., 1973; reprinted, 1979.

National Park Service. *Respectful Rehabilitation: Answers to Your Questions About Old Buildings*. Washington, DC: The Preservation Press, 1982.

New York Landmarks Conservancy. *Repairing Old and Historic Windows*. Washington, D C: The Preservation Press, 1992.

Old House Journal. Numerous articles dealing with historic windows, doors, paints, roofing, foundations, porches, shutters, and other topics.

Preservation Briefs. Washington, DC: National Park Service. Series of technical briefs on various building conservation topics.

Preservation Tech Notes. Washington, DC: National Park Service. Series of technical briefs on various building conservation topics.

Shivers, Natalie. *Walls and Moldings: How to Care for Old and Historic Wood and Plaster*. Washington, DC: The Preservation Press, 1990.

Timmons, Sharon. *Preservation and Conservation: Principles and Practices*. Proceedings of the North American International Regional Conference, Williamsburg, Virginia, and Philadelphia, Pennsylvania, September 10-16, 1972. Washington, DC: Smithsonian Institution Press for the Preservation Press, 1976.

HISTORIC DISTRICTS AND PRESERVATION PLANNING

Duerksen, Christopher J. *A Handbook on Historic Preservation Law*. Washington, DC: The Conservation Foundation and the National Center for Preservation Law, 1983.

Lang, J. Christopher. *Building with Nantucket in Mind; Guidelines for Protecting the Historic Architecture and Landscape of Nantucket Island*. Nantucket, MA: Nantucket Historic District Commission, 1978.

Symonds, Pringle Hart. "Creation of a Historic District in Annapolis," in *The Magazine Antiques* CXI: 1 (January 1977), pp. 146-147.

Wright, St. Clair. "Historic Preservation in Annapolis," in *The Magazine Antiques* CXI: 1 (January 1977), pp. 152-157.

Index

Chapter 3 Design Guidelines

PROPOSED WORK	PAGE	SUBSECTION	PROPOSED WORK	PAGE	SUBSECTION
ADA access	41	C.3	Porches	40, 50	B.12, D.23, D.24
Additions	38	B.6	Reconstruction	39	B.9
Alterations, historic	43	D.4	Repair,	44	D.5
Archaeology	53	E	replace	44	D.6
Awnings	53	D.36	Roofs,	39	B.8
Blinds	49-50	D.21, D.22	materials	45	D.10
Bricks	42, 47	C.11, D.14	systems	44	D.9
Chimney	50	D.25	Sandblasting	44	D.7
Cleaning	44	D.7	(not permitted)		
Cornice	37, 38	B.4, B.7	Scale	37	B.5
Curb cuts	42	C.10	Setbacks	39	B.10
Doors	47-49	D.16-D.19	Shutters	49, 50	D.21, D.22
Dormers	46	D.11	Sidewalks	42	C.11
Driveways	40	B.13	Siding, Trim	47	D.15
Facades	37	B.4	vinyl	47	D.15
Fences	41	C.6	Signage	53	D.37
Garages	40	B.13	Skylights	46	D.12
Height, Bulk	37	B.3, B.5	Standards	43	D
Iron, ornamental	51	D.26	Stoops	40, 50	B.12, D.23, D.24
Landscape	40	C.1	Storefronts,	52-53	
Lighting,			historic	53	D.33
additions	52	D.32	new	53	D.34-D.35
exterior	51	D.30	Street Address	51	D.27
fixtures	52	D.31	Street Furniture	42	C.12
landscape	42	C.7	Trees	41	C.4
new buildings	52	D.32	Utilities, connections	51	D.29
Masonry	46	D.13	Vinyl (not permitted)		
materials	51	D.28	siding	47	D.15
new	47	D.14	windows	48	D.16
New buildings	34, 36	A.1, B.1, B.2	Walls, retaining	41	C.7
Paint colors	44	D.8	Windows,	47-49	D.16-D.20
Parking, off-street	42	C.10	additions	48	D.18
Plants	42	C.9	new openings	48	D.17
Planters	42	C.8	sashes	49	D.20

The Annapolis Historic Preservation Commission

145 Gorman Street, 3rd Floor
Annapolis, Maryland 21401
(410) 263-7941 • histpres@annapolis.gov

The Annapolis Historic Preservation Commission is one part of a network of preservation and planning entities in the city and state. The following agencies can provide help in a variety of circumstances.

For information on planning related services contact:

Department of Planning and Zoning
145 Gorman Street, 3rd Floor
Annapolis, Maryland 21401
(410) 263-7961
Fax (410) 263-1129

For building permits and the building code, contact:

Department of Neighborhood
and Environmental Programs
160 Duke of Gloucester Street
Annapolis, Maryland 21401
(410) 263-7946

For technical assistance, historic plaques, research, and other services (as a private, non-profit historic preservation organization, Historic Annapolis may charge a fee to cover the staff time required), contact:

Historic Annapolis Foundation
18 Pinkney Street
Annapolis, Maryland 21401
(410) 267-7619

For technical publications, investment tax credits, or a copy of *The Secretary of the Interior's Standards for Rehabilitation*, contact:

Maryland Department of Planning
Maryland Historical Trust
100 Community Place, 3rd Floor
Crownsville, Maryland 21032
(410) 514-7600



View from State House Dome, about 1891. (Mame Warren Collection, Maryland State Archives, MSA SC 985-269)

Building in the Fourth Century

THE ANNAPOLIS HISTORIC PRESERVATION COMMISSION

145 Gorman Street, Third Floor

Annapolis, Maryland 21401

410-263-7941 • www.annapolis.gov/citizens/boards/hist_pres/historic



The Mayor and Aldermen of the City of Annapolis
160 Duke of Gloucester Street, Annapolis, Maryland 21401
410-263-1183 • www.annapolis.gov